

Trademarks

Autel®, MaxiSys®, MaxiDAS®, MaxiScan®, MaxiTPMS®, MaxiRecorder®, and MaxiCheck® are trademarks of Autel Intelligent Technology Corp., Ltd., registered in China, the United States and other countries. All other marks are trademarks or registered trademarks of their respective holders.

Copyright Information

No part of this manual may be reproduced, stored in a retrieval system or transmitted, in any form or by any means, electronic, mechanical, photocopying, recording, or otherwise without the prior written permission of Autel.

Disclaimer of Warranties and Limitation of Liabilities

All information, specifications and illustrations in this manual are based on the latest information available at the time of printing.

Autel reserves the right to make changes at any time without notice. While information of this manual has been carefully checked for accuracy, no guarantee is given for the completeness and correctness of the contents, including but not limited to the product specifications, functions, and illustrations.

Autel will not be liable for any direct, special, incidental, indirect damages or any economic consequential damages (including lost profits).

IMPORTANT

Before operating or maintaining this unit, please read this manual carefully, paying extra attention to the safety warnings and precautions.

For Services and Support:



pro.autel.com
www.autel.com



1-855-288-3587/1-855-AUTELUS (North America)
0086-755-86147779 (China)



support@autel.com

For details, please refer to the *Service Procedures* in this manual.

Safety Information

For your own safety and the safety of others, and to prevent damage to the device and vehicles upon which it is used, it is important that the safety instructions presented throughout this manual be read and understood by all persons operating or coming into contact with the device.

There are various procedures, techniques, tools, and parts for servicing vehicles, as well as in the skill of the person doing the work. Because of the vast number of test applications and variations in the products that can be tested with this equipment, we cannot possibly anticipate or provide advice or safety messages to cover every circumstance. It is the automotive technician's responsibility to be knowledgeable of the system being tested. It is crucial to use proper service methods and test procedures. It is essential to perform tests in an appropriate and acceptable manner that does not endanger your safety, the safety of others in the work area, the device being used, or the vehicle being tested.

Before using the device, always refer to and follow the safety messages and applicable test procedures provided by the manufacturer of the vehicle or equipment being tested. Use the device only as described in this manual. Read, understand, and follow all safety messages and instructions in this manual.

Safety Messages

Safety messages are provided to help prevent personal injury and equipment damage. All safety messages are introduced by a signal word indicating the hazard level.

DANGER

Indicates an imminently hazardous situation which, if not avoided, will result in death or serious injury to the operator or to bystanders.

WARNING

Indicates a potentially hazardous situation which, if not avoided, could result in death or serious injury to the operator or to bystanders.

Safety Instructions

The safety messages herein cover situations Autel is aware of. Autel cannot know, evaluate or advise you as to all of the possible hazards. You must be certain that any condition or service procedure encountered does not jeopardize your personal safety.

DANGER

When an engine is operating, keep the service area **WELL VENTILATED** or attach a building exhaust removal system to the engine exhaust system. Engines produce

carbon monoxide, an odorless, poisonous gas that causes slower reaction time and can lead to serious personal injury or loss of life.

 **Do Not Turn the Volume Up Too Loud When Using Headphones**

Listening at high volumes that over-stimulate the ear for long periods of time may result in loss of hearing.

 **SAFETY WARNINGS:**

- Always perform automotive testing in a safe environment.
- Wear safety eye protection that meets ANSI standards.
- Keep clothing, hair, hands, tools, test equipment, etc. away from all moving or hot engine parts.
- Operate the vehicle in a well-ventilated work area, for exhaust gases are poisonous.
- Put the transmission in PARK (for automatic transmission) or NEUTRAL (for manual transmission) and make sure the parking brake is engaged.
- Put blocks in front of the drive wheels and never leave the vehicle unattended while testing.
- Be extra cautious when working around the ignition coil, distributor cap, ignition wires and spark plugs. These components create hazardous voltages when the engine is running.
- Keep a fire extinguisher suitable for gasoline, chemical, and electrical fires nearby.
- Do not connect or disconnect any test equipment while the ignition is on or the engine is running.
- Keep the test equipment dry, clean, free from oil, water or grease. Use a mild detergent on a clean cloth to clean the outside of the equipment as necessary.
- Do not drive the vehicle and operate the test equipment at the same time. Any distraction may cause an accident.
- Refer to the service manual for the vehicle being serviced and adhere to all diagnostic procedures and precautions. Failure to do so may result in personal injury or damage to the test equipment.
- To avoid damaging the test equipment or generating false data, make sure the vehicle battery is fully charged and the connection to the vehicle DLC is clean and secure.
- Do not place the test equipment on the distributor of the vehicle. Strong electro-magnetic interference can damage the equipment.

CONTENTS

1	USING THIS MANUAL	1
	CONVENTIONS	1
2	GENERAL INTRODUCTION	3
	MAXISYS DISPLAY TABLET	3
	VCI – WIRELESS DIAGNOSTIC INTERFACE	7
	ACCESSORIES KIT	8
3	GETTING STARTED	10
	POWER UP	10
	POWER DOWN.....	13
4	DIAGNOSTICS	14
	ESTABLISH VEHICLE COMMUNICATION	14
	GETTING STARTED	18
	VEHICLE IDENTIFICATION	19
	NAVIGATION	21
	MAIN MENU	25
	DIAGNOSIS.....	25
	GENERIC OBD II OPERATIONS.....	37
	EXIT DIAGNOSTICS	41
5	SERVICE	43
	OIL RESET SERVICE	43
	ELECTRIC PARKING BRAKE (EPB) SERVICE	44
	TIRE PRESSURE MONITORING SYSTEM (TPMS) SERVICE	44
	BATTERY MANAGEMENT SYSTEM (BMS) SERVICE	45
	STEERING ANGLE SENSOR (SAS) SERVICE	45
	DIESEL PARTICLE FILTER (DPF) SERVICE	46
	IMMOBILIZER (IMMO) SERVICE	47
6	MAXIFIX	48
	NAVIGATION	48
	OPERATIONS	51
7	SHOP MANAGER	56
	VEHICLE HISTORY.....	57
	WORKSHOP INFORMATION	59
	CUSTOMER MANAGER.....	59
8	DATA MANAGER	63

OPERATIONS	63
9 SETTINGS.....	67
OPERATIONS	67
10 UPDATE	72
11 VCI MANAGER.....	74
BT PAIRING	75
12 REMOTE DESK.....	76
OPERATIONS	76
13 SUPPORT	78
PRODUCT REGISTRATION	78
SUPPORT SCREEN LAYOUT.....	78
MY ACCOUNT	79
USER COMPLAINT	80
DATA LOGGING.....	82
COMMUNITIES	82
TRAINING CHANNELS	84
FAQ DATABASE	84
14 ACADEMY	86
15 QUICK LINK	87
16 MAXISCOPE	88
17 DIGITAL INSPECTION	89
ADDITIONAL ACCESSORIES	90
OPERATIONS	93
18 MAINTENANCE AND SERVICE	95
MAINTENANCE INSTRUCTIONS	95
TROUBLESHOOTING CHECKLIST	95
ABOUT BATTERY USAGE	96
SERVICE PROCEDURES	97
19 COMPLIANCE INFORMATION	100
20 WARRANTY	102
12-MONTH LIMITED WARRANTY	102

1 Using This Manual

This manual contains device usage instructions.

Some illustrations shown in this manual may contain modules and optional equipment that are not included in your system.

Conventions

The following conventions are used.

Bold Text

Bold text is used to highlight selectable items such as buttons and menu options.

Example:

- Tap **OK**.

Notes and Important Messages

Notes

A **NOTE** provides helpful information such as additional explanations, tips, and comments.

Example:

-
-  **NOTE**
New batteries reach full capacity after approximately 3 to 5 charging and discharging cycles.
-

Important

IMPORTANT indicates a situation which, if not avoided, may result in damage to the tablet or vehicle.

Example:

-
-  **IMPORTANT**
Keep the cable away from heat, oil, sharp edges and moving parts. Replace damaged cables immediately.
-

Hyperlink

Hyperlinks or links that take you to other related articles, procedures, and illustrations are available in electronic documents. Blue italic text indicates a selectable hyperlink and blue underlined text indicates a website link or an email address link.

Illustrations

Illustrations used in this manual are samples, and the actual testing screen may vary for each vehicle being tested. Observe the menu titles and on-screen instructions to make correct option selection.

Procedures

An arrow icon indicates a procedure.

Example:

➤ **To use the camera:**

1. Tap the **Camera** button. The camera screen opens.
2. Focus the image to be captured in the view finder.
3. Tap the blue circle. The view finder now shows the captured picture and auto-saves the taken photo.

2 General Introduction

The MaxiSys® MS908S Diagnostic Platform is an evolutionary smart solution for specialized automotive diagnosis. Utilizing the powerful Cortex A7+A15 six-core processor, and a 9.7 inch LED capacitive touch screen, combined with the best possible coverage of OE-level diagnostics, and based on the revolutionary multitask-capable Android Operating system, the MaxiSys organizes information with test instrumentation to help you diagnose symptoms, codes, and customer complaints easily, quickly and efficiently.

There are two main components to the MaxiSys system:

- MaxiSys Display Tablet – the central processor and monitor for the system.
- Vehicle Communication Interface (VCI) – the device for accessing vehicle data.

This manual describes the construction and operation of these devices and how they work together to deliver diagnostic solutions.

MaxiSys Display Tablet

Functional Description

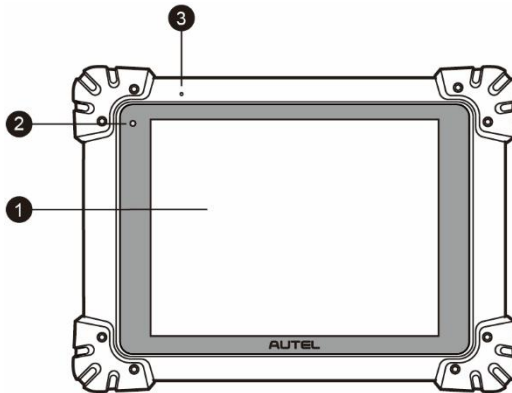

Figure 2-1 MaxiSys Tablet Front View

1. 9.7" LED Capacitive Touch Screen
2. Ambient Light Sensor – detects ambient brightness.
3. Microphone

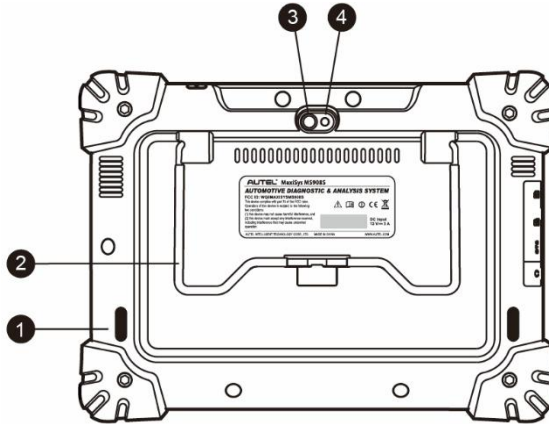

Figure 2-2 MaxiSys Tablet Back View

1. Audio Speaker
2. Collapsible Stand – extends from the back to allow hands-free viewing of the tablet at a 30 degree angle.
3. Camera Lens
4. Camera Flash

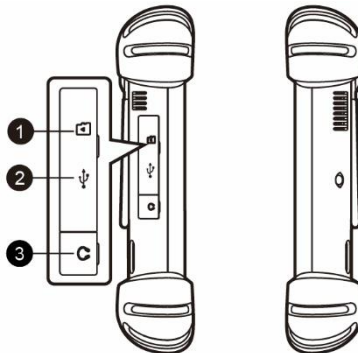

Figure 2-3 MaxiSys Tablet Left Side

1. Mini SD (Secure Digital) Card Slot
2. Mini USB (Universal Serial Bus) Port (it cannot be used at the same time with the No. 4 USB Port in [Figure 2-4 MaxiSys Tablet Top View](#))
3. Head Phone Jack

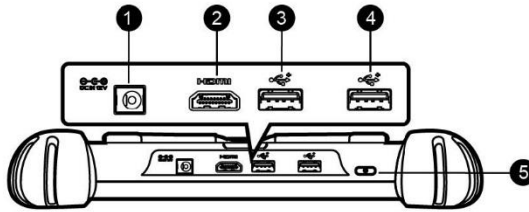

Figure 2-4 MaxiSys Tablet Top View

1. DC Power Supply Input Port
2. HDMI (High-Definition Multimedia Interface) Port
3. USB Port
4. USB Port (it cannot be used at the same time with the Mini USB Port in [Figure 2-3 MaxiSys Tablet Left Side](#))
5. Lock/Power Button – long press to turn on and off MaxiSys, or short press to lock the screen.

Power Sources

The tablet can receive power from any of the following sources:

- Internal Battery Pack
- AC/DC Power Supply
- Vehicle Power

! IMPORTANT

Please charge the battery with the ambient temperature between 0°C and 45°C. If charge the battery when the temperature is out of range, the battery may catch on fire.

Internal Battery Pack

The tablet can be powered with the internal rechargeable battery, which if fully charged can provide sufficient power for about 7.5 hours of continuous operation.

AC/DC Power Supply

The tablet can be powered from a wall socket using the AC/DC power adapter. The AC/DC power supply also charges the internal battery pack.

Vehicle Power

The tablet can be powered from the cigarette lighter or other suitable power port on the test vehicle through a direct cable connection. The vehicle power cable connects to the DC power supply port on the top side of the display unit.

Technical Specifications

Table 2-1 Tablet Specifications

Item	Description
Operating System	Android™ 4.4.2, KitKat
Processor	Samsung Exynos Six-core Processor (1.3GHz Quad-core ARM Cortex-A7 + 1.7GHz Dual-core ARM Cortex-A15)
Memory	2GB RAM & 64GB On-board Memory
Display	9.7 inch LED capacitive touch screen with 1024x768 resolution
Connectivity	Wi-Fi (802.11 a/b/g/n/ac) USB: 2.0 BT v.2.1 + EDR SD Card (Support up to 32GB) HDMI
Camera (rear)	8.0 Megapixel, AF with Flashlight
Sensors	Gravity Accelerometer, Ambient Light Sensor (ALS)
Audio Input/Output	Microphone Dual Speakers 3-Band 3.5 mm stereo/standard headset jack
Power and Battery	11000 mAh 3.7 V lithium-polymer battery Charging via 12 V AC/DC power supply with the temperature between 0°C and 45°C
Input Voltage	12 V (9-24 V)
Power Consumption	6.5 W
Operating Temp.	0 to 50°C (32 to 122°F)
Storage Temp.	-20 to 60°C (-4 to 140°F)
Dimensions (WxHxD)	300 mm (11.81") x 220 mm (8.66") x 50 mm (1.97")
Weight	NW: 1.42 kg (3.13 lb.) GW: 8.655 kg (19.08 lb.)

Item	Description
Protocols	ISO 9142-2, ISO 14230-2, ISO 15765-4, K/L-Line, Flashing Code, SAE-J1850 VPW, SAE-J1850 PWM, CAN ISO 11898, Highspeed, Middlespeed, Lowspeed and Singlewire CAN, GM UART, UART Echo Byte Protocol, Honda Diag-H Protocol, TP 2.0, TP 1.6, SAE J1939, SAE J1708, Fault-Tolerant CAN

VCI – Wireless Diagnostic Interface

Functional Description

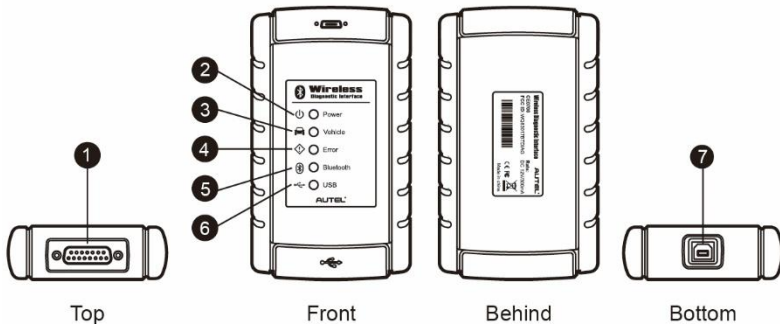

Figure 2-5 Wireless Diagnostic Interface

1. Vehicle Data Connector (DB15-Pin)
2. Power LED – lights solid green when the device is powered on.
3. Vehicle LED – blinks green when the device is communicating with the vehicle's network.
4. Error LED – lights solid red when serious hardware failure occurs; also blinks red when the device is updating software/firmware.
5. BT LED – lights solid green when the device is connected with the tablet through BT communication.
6. USB LED – lights solid green when the device is properly connected and communicating with the tablet via the USB cable.
7. USB Port

Communication

The Wireless Diagnostic Interface supports both BT and USB communication. It can transmit vehicle data to the tablet with or without a physical connection. The working range of the transmitter through BT communication is about 755 feet (about 230 m). A

signal lost due to moving out of range automatically restores itself when the display unit is brought closer to the VCI unit.

Technical Specifications

Table 2-2 Wireless Diagnostic Interface Specifications

Item	Description
Communications	BT V.2.1 + EDR; USB 2.0
Wireless Frequency	2.4 GHz
Input Voltage Range	12 VDC
Supply Current	200 mA @ 12 VDC
Operating Temp.	0°C to 50°C (ambient)
Storage Temp.	-20°C to 70°C (ambient)
Dimensions (LxWxH)	147.5 mm (5.80") x 85.5 mm (3.37") x 29.0 mm (1.14")
Weight	215 g (0.473 lb.)

Power Sources

The Wireless Diagnostic Interface operates on 12-volt vehicle power, which it receives through the vehicle data connection port. The unit powers on whenever it is connected to an OBD II/EOBD compliant data link connector (DLC).

Accessories Kit

Main Cable

The VCI device can be powered through the Main Cable when connected to an OBD II/EOBD compliant vehicle. The Main Cable connects the VCI device to the vehicle's data link connector (DLC), through which the VCI device can transmit vehicle data to the tablet.

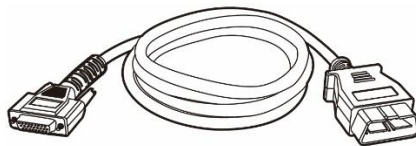

Figure 2-6 Main Cable – 1.5 m in length

OBD I Adapters

The OBD I adapters are for Non-OBD II vehicles. The adapter used depends on the type of vehicle being tested. The most common adapters are shown.



Benz-14
(EU Only)



Chrysler-16
(America Only)



BMW-20



Kia-20



Nissan-14



GM/Daewoo-12



Honda-3



Benz-38



VW/Audi-2+2



Mitsubishi/Hyundai-12+16

Other Accessories



Standard 2.0 USB Cable

Connects the tablet to the VCI unit.



Mini USB Cable

Connects the tablet to the Windows-based PC.



AC/DC External Power Adapter

Connects the tablet to the external DC power port for power supply.



Cigarette Lighter

Provides power to the tablet or the VCI device through connection to the vehicle's cigarette lighter receptacle, as some non-OBD II vehicles cannot provide power via the DLC connection.

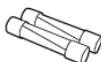

Lighter Fuse x2

A safety device for the cigarette lighter.

3 Getting Started

Make sure the tablet has sufficient power or is connected to the external power supply (see [Power Sources](#) on page 5).

Power Up

Long press the Lock/Power button on the top right side of the tablet to switch the unit on. The power LED will illuminate green. The system boots up and displays the lock screen. Press and drag the inner ring to the edge of the circle to unlock the screen; the MaxiSys Job Menu displays.

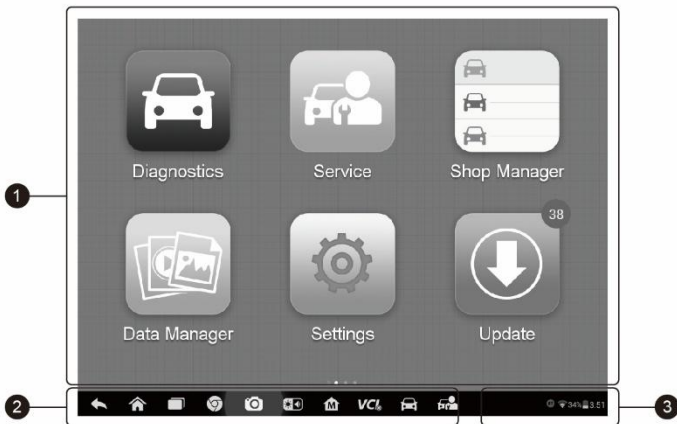

Figure 3-1 Sample MaxiSys Job Menu

1. Application Buttons
2. Locator and Navigation Buttons
3. Status Icons

NOTE













The screen is locked by default upon startup. It is recommended to lock the screen when not in use to protect information in the system and conserve the power.



Almost all operations on the tablet are controlled through the touch screen. The touch screen navigation is menu driven, which allows you to quickly locate the test procedure, or data that you need, through a series of choices and questions. Detailed descriptions of the menu structures are found in the chapters for each application.

Application Buttons

The table below briefly describes each of the applications in the MaxiSys system.

Table 3-1 Applications









Name	Button	Description
Diagnostics		Accesses the unit's diagnostics functions. See Diagnostics on page 14.
Service		Accesses special functions menu. See Service on page 43 for details.
MaxiFix		Launches the MaxiFix platform that provides the most compatible and abundant repair techniques and diagnostics database. See MaxiFix on page 48.
Shop Manager		Accesses Shop Manager database to store workshop, consumer information and vehicle test history. See Shop Manager on page 56.
Data Manager		Accesses the organization system for saved data files. See Data Manager on page 63.
Settings		Accesses the system settings menu and general tablet menu. See Settings on page 67.
Update		Accesses system software update menu. See Update on page 72.
VCI Manager		Accesses VCI connection menu. See VCI Manager on page 74.
Support		Launches the Support platform that synchronizes Autel's online service base station with the MaxiSys tablet. See Support on page 78.
Academy		Accesses technical tutorials and training articles about the device or vehicle diagnostic techniques. See Academy on page 86 for details.
Remote Desk		Configures your unit to receive remote support using the TeamViewer application. See Remote Desk on page 76.
Quick Link		Provides associated website bookmarks to allow quick access to product update, service, support and other information. See Quick Link on page 87.



Name	Button	Description
MaxiScope		Configures the unit to operate as an automotive oscilloscope to perform electrical and electronic circuit tests and monitor signal activities. See MaxiScope on page 88.
Digital Inspection		Configures the unit to operate as a video scope device by connecting to an Imager head cable for close vehicle inspections. See Digital Inspection on page 89.

Locator and Navigation Buttons

Operations of the Navigation buttons are described as below:

Table 3-2 Locator and Navigation Buttons

Name	Button	Description
Locator		Indicates the location of the screen. Swipe the screen left or right to view the previous or next screen.
Back		Returns to the previous screen.
Android Home		Returns to Android System's Home screen.
Recent Apps		Displays a list of applications that are currently working. Tap an app icon to launch. To remove an app, swipe it to the right.
Browser		Launches the Chrome Internet browser.
Camera		Opens the camera with short press; takes and saves screenshot image with long press. The saved files are auto-stored in the Data Manager application for later reviews. See Data Manager on page 63.
Display & Sound		Allows you to adjust the brightness of the screen and the volume of the audio output.
MaxiSys Home		Returns to MaxiSys Job Menu.
VCI		Opens the VCI Manager application. The check at the bottom right corner indicates the tablet is communicating with the VCI, an X will display if the tablet is not connected to VCI.

Name	Button	Description
MaxiSys Shortcut		Returns to the Diagnostics screen.
Service		Returns to the Service screen.

➤ **To use the camera:**

1. Tap the **Camera** button. The camera screen opens.
2. Focus the image to be captured in the view finder.
3. Tap the inner blue circle. The view finder now shows the captured picture and auto-saves the taken photo.
4. Tap the thumbnail image on the top right corner of the screen to view the stored image.
5. Tap the **Back** or **Home** button to exit the camera application.

Refer to Android documentation for additional information.

System Status Icons

These are the standard status icons of the Android operating system. Your MaxiSys display tablet is a fully functional Android Pad. Refer to Android documentation for additional information.

Power Down

All vehicle communications must be terminated before shutting down the tablet. A warning message displays if a shutdown is attempted while the tablet is communicating with the vehicle. Forcing a shut down while the tablet is communicating may lead to ECM problems on some vehicles. Please exit the Diagnostics application before shutting off the tablet.

➤ **To power down the MaxiSys tablet:**

1. Long press the Lock/Power Button.
2. Tap **Power off** option.
3. Tap **OK**.

Reboot System

In case of system crash, long press the Lock/Power button and tap **Reboot** to restart the system.

4 Diagnostics

The Diagnostics application can access the electronic control module (ECM) of various vehicle control systems, such as engine, transmission, antilock brake system (ABS), airbag system (SRS) and more.

Establish Vehicle Communication

The Diagnostics operations require connecting the MaxiSys MS908S Diagnostic Platform to the test vehicle through the VCI device using the main cable and test adapters (for non-OBD II vehicles). To establish proper vehicle communication to the tablet, you need to perform the following steps:

1. Connect the VCI device to the vehicle's DLC for both communication and power source.
2. Connect the VCI device to the tablet via BT pairing, or USB connection.
3. When the above steps are completed, check the VCI navigation button at the bottom bar on the screen, if a green check displays at the lower right corner, the MaxiSys MS908S Diagnostic Platform is ready to start vehicle diagnosis.

Vehicle Connection

The method used to connect the VCI device to a vehicle's DLC depends on the vehicle's configuration as follows:

- A vehicle equipped with an On-board Diagnostics Two (OBD II) management system supplies both communication and 12-volt power through a standardized J-1962 DLC.
- A vehicle not equipped with an OBD II management system supplies communication through a DLC connection, and in some cases supplies 12-volt power through the cigarette lighter receptacle or a connection to the vehicle battery.

OBD II Vehicle Connection

This type of connection only requires the main cable without any additional adapter.

➤ **To connect to an OBD II vehicle**

1. Connect the main cable's female adapter to the Vehicle Data Connector on the VCI device, and tighten the captive screws.

2. Connect the cable's 16-pin male adapter to the vehicle's DLC, which is generally located under the vehicle dashboard.

 **NOTE**

The vehicle's DLC is not always located under the dashboard; refer to the user manual of the test vehicle for additional connection information.

Non-OBD II Vehicle Connection

This type of connection requires both the main cable and a required OBD I adapter for the specific vehicle being serviced.

There are three possible conditions for Non-OBD II vehicle connection:

- DLC connection supplies both communication and power.
- DLC connection supplies communication and power is to be supplied via the cigarette lighter connection.
- DLC connection supplies communication and power is to be supplied via connection to the vehicle battery.

➤ **To connect to a Non-OBD II Vehicle**

1. Connect the main cable's female adapter to the Vehicle Data Connector on the VCI device, and tighten the captive screws.
2. Locate the required OBD I adapter and connect its 16-pin jack to the main cable's male adapter.
3. Connect the attached OBD I adapter to the vehicle's DLC.

 **NOTE**

Some adapters may have more than one adapter or may have test leads instead of an adapter. Whatever the case, make the proper connection to the vehicle's DLC as required.

➤ **To connect the cigarette lighter**

1. Plug the DC power connector of the cigarette lighter into the DC power supply input port on the device.
2. Connect the male connector of the cigarette lighter into the vehicle's cigarette lighter receptacle.

 **NOTE**

After the VCI device is successfully connected to the vehicle, the Power LED on the device illuminates, and a brief beep sound will be heard.

VCI Connection

After the VCI device is properly connected to the vehicle, the Power LED on the VCI device illuminates solid green, and is ready to establish communication with the tablet.

The Wireless Diagnostic Interface supports 2 communication methods with the tablet: BT and USB.

Pairing Up via BT

Among all methods, BT pairing is recommended as the first choice for the communication between the tablet and the VCI device. The working range for BT communication is about 210 feet (70 m); this means you can perform vehicle diagnosis freely around the workshop with greater convenience.

If you use more than one VCI device to connect to the test vehicles when customers are many, you can perform vehicle diagnosis on various vehicles conveniently, by pairing the tablet separately to each of the VCI devices connected to the different test vehicles, via BT, without the need to repeat the plugging and unplugging procedure, which is unavoidable through traditional wired connection, thus saves you more time and provides more efficiency.

➤ **To pair up the tablet with the VCI device via BT**

1. If not already done, power up the tablet.
2. Select the **VCI Manager** application from the MaxiSys Job Menu.
3. When the **VCI Manager** application is opened, the device automatically starts scanning for available VCI devices around for BT pairing. The found devices are listed in the Setting section on the right side of the screen.

NOTE

If no VCI device is found, this may indicate that the signal strength of the transmitter is too weak to be detected. In this case try to get closer to the device, or reposition the VCI device, and remove all possible objects that may cause signal interference. When done, tap the **Scan** button at the top right corner to start searching again.

4. The VCI device name displays as Maxi suffixed with a serial number. Select the required device for pairing.
5. When pairing is successfully done, the connection status displayed to the right of the device name is shown as Paired.
6. Wait for a few seconds, and the VCI button on the system Navigation bar at the bottom of the screen shall display a green check, indicating the tablet is connected to the VCI device, and is ready to perform vehicle diagnosis.

Refer to [BT Pairing](#) on page 75 for additional information.

USB Cable Connection

The USB cable connection is a simple and quick way to establish communication between the tablet and the VCI device. After properly connecting the USB cable from the tablet to the VCI device, the VCI navigation button at the bottom bar of the screen shows a green check in a few seconds, and the USB LED on the VCI device illuminates solid green, indicating the connection between the devices is successful.

The MaxiSys diagnostic platform is now ready to perform vehicle diagnosis.

No Communication Message

- A. If the tablet is not connected to the VCI device, an “Error” message displays. An “Error” message indicates the tablet is not communicating with the VCI device, and so cannot gain access to the vehicle control module. In this case, you need to do the following check-ups:
- Check if the VCI device is powered on.
 - In case of wireless connection, check if the network is configured correctly, or if the right device has been paired.
 - If during the diagnosis process, communication is suddenly interrupted due to the loss of signal, check if there are any objects that causes signal interruption.
 - Check if the VCI device is properly positioned. It is recommended to put the VCI device with the front side up.
 - Try standing closer to the VCI device to obtain more stable signals, and faster communication speed. In case of wired connection, check the cable connection between the tablet and the VCI device.
 - Check if the green LED on the VCI device is illuminated for BT or USB.
 - Check if the Error LED on the VCI device is on, this may indicate there is a communication error between the devices, in this case try re-establishing the connection again; if this does not work, there may be a hardware problem with the device, in this case contact Autel or local distributor for technical support.
- B. If the VCI device is unable to establish a communication link, a prompt message displays with check instructions. The following conditions are the possible causes for this message to display:
- The VCI device is unable to establish a communication link with the vehicle.
 - You’ve selected a system for testing that the vehicle is not equipped with.
 - There is a loose connection.
 - There is a blown vehicle fuse.
 - There is a wiring fault on the vehicle, or the data cable or adapter.
 - There is a circuit fault in the data cable or adapter.

- Incorrect vehicle identification was entered.

Getting Started

Prior to first use of the Diagnostics application, the VCI device must be synchronized with the tablet to establish a communication link. See [VCI Manager](#) on page 74.

Vehicle Menu Layout

When the VCI device is properly connected to the vehicle, and paired to the tablet, the platform is ready to start vehicle diagnosis. Tap on the Diagnostics application button on the MaxiSys Job Menu, the screen then opens the Vehicle Menu.



Figure 4-1 Sample Vehicle Menu Screen









1. Top Toolbar Buttons
2. Manufacturer Buttons

Top toolbar Buttons

The operations of the Toolbar buttons at the top of the screen are listed and described in the table below:

Table 4-1 Top Toolbar Buttons

Name	Button	Description
Home		Returns to the MaxiSys Job Menu.
VIN Scan		Touching this button opens a dropdown list; tap Auto Detect for auto VIN detection; tap Manual Input to enter VIN manually.

Name	Button	Description
All		Displays all the vehicle makes in the vehicle menu.
History		Displays the stored test vehicle history records. This option provides you direct access to the tested vehicle recorded during previous test sessions. See Vehicle History on page 57.
USA		Displays the USA vehicle menu.
Europe		Displays the European vehicle menu.
Asia		Displays the Asian vehicle menu.
China		Displays the Chinese vehicle menu.
Search		Touching this button opens the virtual keyboard, allowing you to manually enter the specific vehicle make required for search.
Cancel		Touching this button exits the search screen, or cancels an operation.

Manufacturer Buttons

The Manufacturer Buttons display the various vehicle logos and the brand names. Select the required manufacturer button after the VCI device is properly connected to the test vehicle to start a diagnostic session.

Vehicle Identification

The Maxisys diagnostic system supports four methods for Vehicle Identification.

1. Auto VIN Scan
2. Manual VIN Input
3. Manual Vehicle Selection
4. OBD Direct Entry

Auto VIN Scan

The MaxiSys diagnostic system features the latest VIN-based Auto VIN Scan function to identify CAN vehicles in just one touch, which allows the technician to quickly detect vehicles, scan all the diagnosable ECUs on every vehicle and run diagnostics on the selected system.

➤ **To perform Auto VIN Scan**

1. Tap the **Diagnostics** application button from the MaxiSys Job Menu. The Vehicle Menu displays.
2. Tap the **VIN Scan** button on the top toolbar.
3. Select **Auto Detect**. The tester starts VIN scanning on the vehicle's ECU. Once the test vehicle is successfully identified, the system will guide you to the Vehicle Diagnostics screen directly.

In some cases when users have selected the vehicle brand instead of performing Auto VIN Scan in the first place, the system still provides an option for vehicle VIN scan.

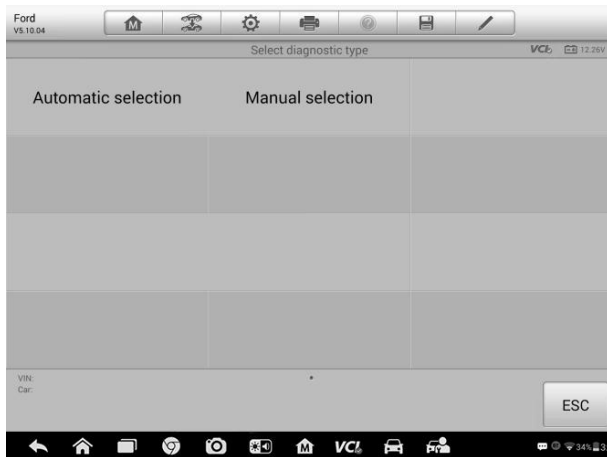

Figure 4-2 Sample Vehicle Selection Screen

Select **Automatic Selection** and the system will proceed to acquire VIN information automatically or allow users to input the VIN manually.

Manual VIN Input

For some vehicles that do not support the Auto VIN Scan function, the MaxiSys diagnostic system allows you to enter the vehicle VIN manually, or simply take a photo of the VIN sticker for quick vehicle identification.

➤ **To perform Manual VIN Input**

1. Tap the **Diagnostics** application button from the MaxiSys Job Menu. The Vehicle Menu displays.
2. Tap the **VIN Scan** button on the top toolbar.
3. Select **Manual Input**.
4. Tap the input box and enter the correct VIN.

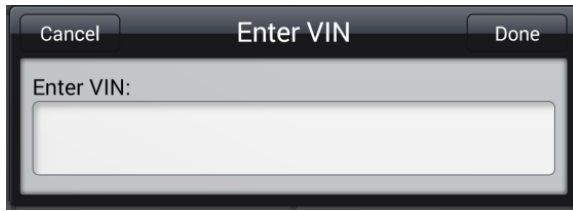

Figure 4-3 Manual VIN Input

5. Tap **Done**. The vehicle will be identified in a few seconds, and once the matching is successful, the system will guide you to the Vehicle Diagnostics screen directly.
6. Tap **Cancel** to exit Manual Input.

Manual Vehicle Selection

When the vehicle's VIN is not automatically retrievable through the vehicle's ECU, or the specific VIN is unknown, you can choose to select the vehicle manually.

Step-by-step Vehicle Selection

This mode of vehicle selection is menu driven; you simply follow the screen prompts and make a series of choices. Each selection you make advances you to the next screen. A **Back** button at the lower right corner of the screen returns you to the previous screen. Exact procedures may vary somewhat by various vehicles being serviced.

Alternative Vehicle Identification

Occasionally, you may identify a test vehicle that the tester does not recognize; the database does not support, or has some unique characteristics that prevent it from communicating with the tester through the normal channels. In these instances, you are provided with the OBD direct entry, through which you can perform generic OBD II or EOBD tests. See [Generic OBD II Operations](#) on page 37 for additional information.

Navigation

This section describes how to navigate the Diagnostics interface and select test options.

Diagnostics Screen Layout

The Diagnostics screens typically include four sections.

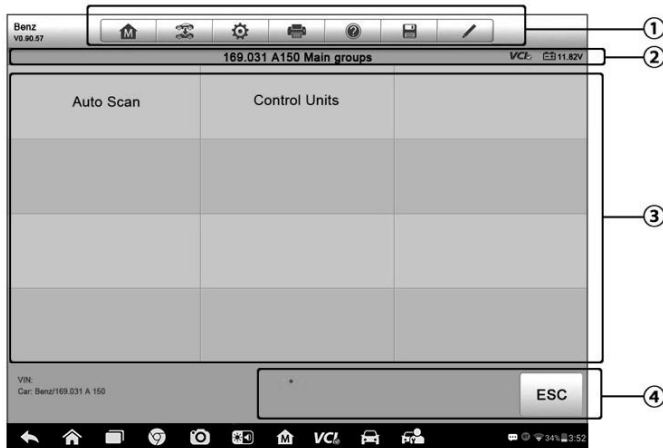

Figure 4-4 Sample Diagnostics Screen



1. Diagnostics Toolbar
2. Status Information Bar
3. Main Section
4. Functional Buttons

Diagnostics Toolbar

The Diagnostics Toolbar contains a number of buttons that allow you to print or save the displayed data and make other controls. The table below provides a brief description for the operations of the Diagnostics toolbar buttons:

Table 4-2 Diagnostics Toolbar Buttons

Name	Button	Description
Home		Returns to the MaxiSys Job Menu.
Vehicle Swap		Exits the diagnostic session and returns to the vehicle menu screen to select another vehicle for testing.
Settings		Opens the setting screen. See Settings on page 67.
Print		Saves and prints a copy of the displayed data. See Print on page 68.
Help		Provides instructions or tips for operations of various diagnostic functions.

Name	Button	Description
Save		<p>Taps it to open a submenu, on which there are 3 options available to save the displayed data.</p> <ul style="list-style-type: none"> ● Tap Save This Page to take a screenshot image ● Tap Save All Data to save a PDF file (mostly used to save data that cover more than 1 page) ● Tap Start Saving to record a video clip (only available for recording Live Data or special graph data) <p>All saved data are stored in the Data Manager application for later reviews. See Data Manager on page 63.</p>
Data Logging		<p>Records the communication data and ECU information of the test vehicle. The saved data can be reported and sent to the technical center via the internet.</p> <p>Go to the Support application to follow up the processing progress, see Data Logging on page 82.</p>
Send		<p>Taps it to submit the Data Logging report to the technical center via the internet.</p>

➤ **To print data in Diagnostics**

1. Tap the **Diagnostics** application button from the MaxiSys Job Menu. The **Print** button on the diagnostic toolbar is available throughout the whole Diagnostics operations.
2. Tap **Print** and a drop-down menu appears.
 - a) **Print This Page** – prints a screenshot copy of the current screen.
 - b) **Print All Page** – prints a PDF copy of all displayed data.
3. A temporary file will be created and sent to the computer for printing.
4. When the file is transferred successfully, a confirmation message displays.

🚫 **NOTE**

Make sure the tablet is connected to the computer network, either via WiFi or LAN, before printing. For more instructions on printing, see [Print](#) on page 68.

➤ **To submit Data Logging reports in Diagnostics**

1. Tap the **Diagnostics** application button from the MaxiSys Job Menu. The **Data Logging** button on the diagnostic toolbar is available throughout the whole Diagnostics operations.

2. Tap the **Data Logging** button. The button displays blue during the active recording process.
3. Tap the **Data Logging** button again to finish recording. A submission form will display to let you fill in the report information.
4. Tap the **Send** button to submit the report form via the internet, a confirmation message displays when sending is successful.

Status Information Bar

The Status Information Bar at the top of the Main Section displays the following items:

1. Menu Title – indicates the menu subject of the Main Section.
2. VCI Icon – indicates the communication status between the tablet and the VCI device.
3. Battery Icon – indicates the battery status of the vehicle.

Main Section

The Main Section of the screen varies depending on the stage of operations. The Main Section can show vehicle identification selections, the main menu, test data, messages, instructions and other diagnostic information.

Functional Buttons

The displayed Functional Buttons at this section of the screen varies depending on the stage of operations. They can be used to navigate, save or clear the diagnostic data, exit scanning as well as make other functional controls. The functions of these buttons will be introduced respectively in the following sections of the corresponding test operations.

Screen Messages

Screen messages appear when additional input is needed before proceeding. There are mainly three types of on-screen messages as to their purposes: Confirmation, Warning, and Error.

Confirmation Messages

This type of messages usually displays as an “Information” screen, which informs you when you are about to perform an action that cannot be reversed or when an action has been initiated and your confirmation is needed to continue.

When a user-response is not required to continue, the message displays briefly before automatically disappearing.

Warning Messages

This type of messages informs you when completing the selected action may result in an irreversible change or loss of data. The typical example for this is the “Erase Codes” message.

Error Messages

Error messages inform you when a system or procedural error has occurred. Examples of possible errors include a disconnected cable or communication interruption due to certain reasons.

Making Selections

The Diagnostics application is a menu driven program that presents a series of choices one at a time. As you select from a menu, the next menu in the series displays. Each selection narrows the focus and leads to the desired test. Use your fingertip or the stylus pen to make menu selections.

Main Menu

The Diagnostics application allows you to establish a data link to the electronic control system of the test vehicle via the VCI device for vehicle diagnosis, service or programming. You can operate functional tests, retrieve vehicle diagnostic information such as trouble codes, event codes and live data, and perform ECU reprogramming, for various vehicle control systems, such as engine, transmission, ABS and more.

The Vehicle Diagnostics screen has two main options:

1. **Diagnosis** – a comprehensive section which includes all available functions: reading, clearing, saving and printing diagnostic information, as well as performing active tests and special functions.
2. **Service** – a separate section designed to perform vehicle scheduled service and maintenance, such as to reset the service lights and perform calibration for various systems.

After a section is selected and the tablet establishes communication with the vehicle via the VCI device, the corresponding function menu or selection menu displays.

Diagnosis

There are two options available when accessing the Diagnosis section:

1. **Auto Scan** – starts auto scanning for all the available systems on the vehicle
2. **Control Units** – displays a selection menu of all available control units of the test

vehicle.

Auto Scan

The Auto Scan function performs a comprehensive scanning over all the systems on the vehicle's ECU in order to locate fault systems and retrieve DTCs. The sample operation interface of Auto Scan displays as below:

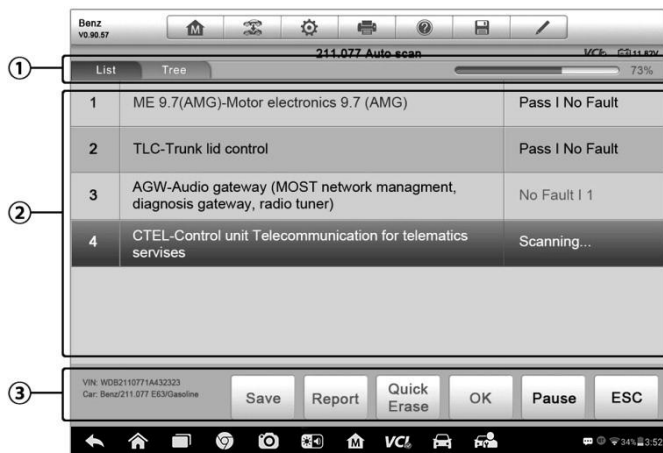

Figure 4-5 Sample Auto Scan Operation Screen

1. Navigation Bar
2. Main Section
3. Functional Buttons

Navigation Bar

1. List Tab – displays the scanned data in list format
2. Tree Tab – display the scanned data in system distribution diagram format
3. Progress Bar – indicates the test progress

Main Section

A. List Tab

Column 1 – displays the system numbers.

Column 2 – displays the scanned systems.

Column 3 – displays the diagnostic marks indicating different conditions of the test result.

- ❖ **-!-**: Indicates that the scanned system may not support the code reading function, or there is a communication error between the tester and the control system.

- ❖ **-?-**: Indicates that the vehicle control system has been detected, but the tester cannot accurately locate it.
- ❖ **Fault | #**: Indicates there is/are detected fault code(s) present; “#” indicates the number of the detected faults.
- ❖ **Pass | No Fault**: Indicates the system has passed the scanning process and no fault has been detected.

B. Tree Tab

The tree tab screen displays a system distribution diagram of the vehicle control modules. The scanned system which has passed scanning with no fault is shown in blue font; whereas the scanned system that has been detected with fault present is shown in red font.

- Tab the > button to the right of the system item, on which you want to perform further diagnosis and other test activities. A Function Menu screen (*Figure 4-6*) shall then display.

Functional Buttons

The table below provides a brief description of the Functional Buttons’ operations in Auto Scan:

Table 4-3 Functional Buttons in Auto Scan

Name	Description
Back	Returns to the previous screen or exit Auto Scan.
Pause	Suspends scanning and changes to show the Continue button.
OK	Confirms the test result, and continues to the system diagnosis after selecting the required system by tapping the item in the Main Section.
Quick Erase	Deletes codes. A warning message screen will display to inform you of possible data loss when this function is selected.
Report	Displays the diagnostic data in the report form.
Save	Saves the diagnostic session as a history record, this allows you to quickly restore access to the test systems.

Control Units

This option allows you to manually locate a required control system for testing through a series of choices. Simply follow the menu driven procedure, and make proper

selection each time; the program will guide you to the diagnostic function menu after a few choices you've made.

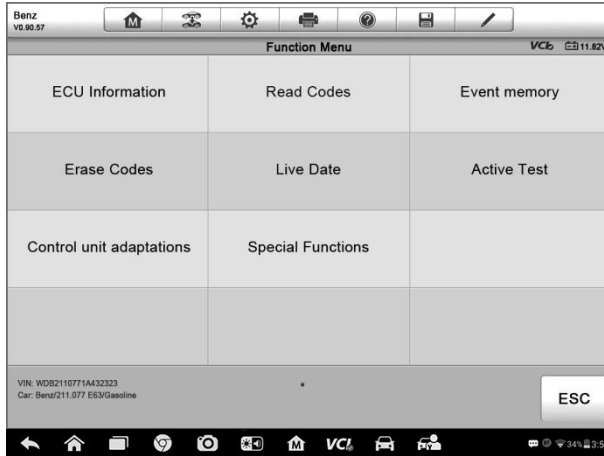

Figure 4-6 Sample Function Menu Screen

The Function Menu options vary slightly for different vehicles. The function menu may include:

- ECU Information – provides the retrieved ECU information in detail. Selecting it opens an information screen.
- Read Codes – displays detailed information of DTC records retrieved from the vehicle control module.
- Erase Codes – erases DTC records and other data from the ECM.
- Live Data – retrieves and displays live data and parameters from the vehicle's ECU.
- Active Test – provides specific subsystem and component tests. This selection may appear as *Actuators*, *Actuator Test*, or *Function Tests* and the tests options vary depending on the vehicle manufacturer and model.
- Special Functions – provides component adaptation or variant coding functions for custom configurations, and also allows you to reprogram adaptive values for certain components after making repairs. Depending on the test vehicle, this selection may sometimes appear as *Control Unit Adaptations*, *Variant Coding*, *Configuration* or something similar.

NOTE

With the diagnostic toolbar on top of the screen throughout the whole diagnostic procedures, you are allowed to make various controls of the diagnostic information at any time, such as print and save the displayed data, get help information, or perform data logging.

➤ **To perform a diagnostic function**

1. Establish communication with the test vehicle via the VCI device.
2. Identify the test vehicle by selecting from the menu options.
3. Select the **Diagnosis** section.
4. Locate the required system for testing by Auto Scan or through menu driven selections in Control Units.
5. Select the desired test from the Function Menu.

ECU Information

This function retrieves and displays the specific information for the tested control unit, including unit type, version numbers and other specifications. The sample ECU Information screen displays as below:

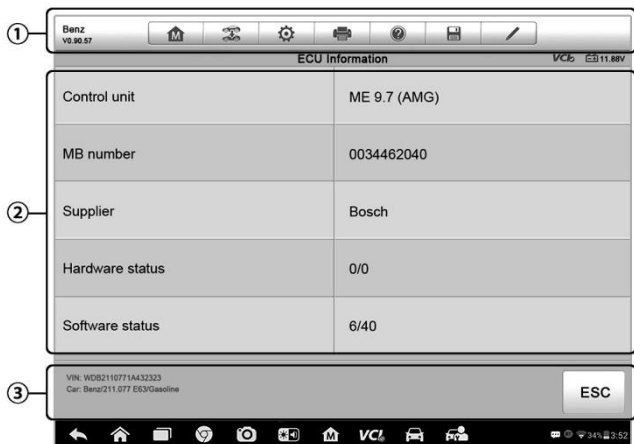

Figure 4-7 Sample ECU Information Screen

1. Diagnostics Toolbar Buttons – see [Table 4-2 Diagnostics Toolbar Buttons](#) on page 22 for detailed descriptions of the operations for each button.
2. Main Section – the left column displays the item names; the right column displays the specifications or descriptions.
3. Functional Button – in this case, only a **Back** (or **ESC**) button is available; tap it to exit after viewing.

Read Codes

This function retrieves and displays the DTCs from the vehicle's control system. The Read Codes screen varies for each vehicle being tested, on some vehicles, freeze frame data can also be retrieved for viewing. The sample Read Codes screen displays as below:

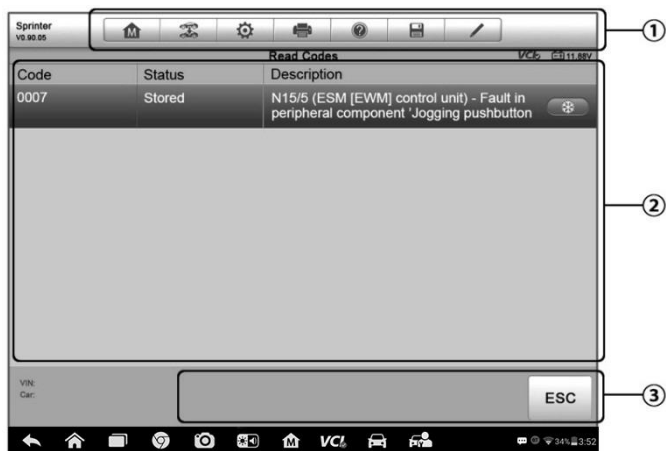

Figure 4-8 Sample Read Codes Screen

1. Diagnostics Toolbar Buttons – see [Table 4-2 Diagnostics Toolbar Buttons](#) on page 22 for details.
2. Main Section
 - Code Column – displays the retrieved codes from the vehicle.
 - Status Column – indicates the status of the retrieved codes.
 - Description Column – detailed descriptions for the retrieved codes.
 - Snowflake Icon – only displays when freeze frame data is available for viewing; Selecting it displays a data screen, which looks very similar to the Read Codes interface, therefore same operation methods may be applied.
3. Functional Button – in this case, only a **Back** (or **ESC**) button is available; tap it to return to the previous screen or exit the function.

Erase Codes

After reading the retrieved codes from the vehicle and certain repairs have been carried out, you can decide to erase the codes from the vehicle using this function. Before performing this function, make sure the vehicle's ignition key is in the ON (RUN) position with the engine off.

➤ To erase codes

1. Tap **Erase Codes** from the Function Menu.
2. A warning message displays to inform you of data loss when this function is applied.
 - a) Tap **Yes** to continue. A confirming screen displays when the operation is successfully done.
 - b) Tap **No** to exit.

3. Tap **ESC** on the confirming screen to exit Erase Codes.
4. Check the Read Codes function again to ensure the operation is successful.

Live Data

When this function is selected, the screen displays the data list for the selected module. The data available for any control module varies from one vehicle to another. The parameters display in the order that they are transmitted by the ECM, so expect variation among vehicles.

Gesture scrolling allows you to quickly move through the data list. Touch the screen and drag your finger up or down to reposition the parameters being displayed if the data populates more than one screen. The figure below displays a typical Live Data screen:

Parameter ID	Parameter Name	Value	Range	Unit
<input type="checkbox"/> PR064	WATER TEMPERATURE	-273.0	-273.0/-173.0	°C
<input type="checkbox"/> PR055	ENGINE SPEED			
<input type="checkbox"/> PR312	MANIFOLD PRESSURE	0.2	0/1	bar
<input type="checkbox"/> PR071	COMPUTER SUPPLY VOLTAGE	0.5	0.0/1.0	V
<input type="checkbox"/> PR887	THROTTLE VALVE SAFE MODE VAL.	0.3	0/1	%
<input type="checkbox"/> PR469	CYLINDER 1 KNOCK VALUE	1		
<input type="checkbox"/> PR471	CYLINDER 1 KNOCK VALUE	0.6		
<input type="checkbox"/> PR473	CYLINDER 1 KNOCK VALUE	0.36		
<input type="checkbox"/> PR475	CYLINDER 1 KNOCK VALUE	2		

Figure 4-9 Sample Live Data Screen

1. Diagnostics Toolbar Buttons – tap the drop-down button at the top center of the screen displays the toolbar buttons. See [Table 4-2 Diagnostics Toolbar Buttons](#) on page 22 for detailed descriptions of the operations for each button.
2. Main Section
 - Name Column – this column displays the parameter names.
 - a) Check Box – tap the check box at the left side of the parameter name to make selection of an item. Tap the check box again to deselect the item.
 - b) Drop-down Button – tap the drop-down button at the right side of the parameter name to open a submenu, which provides optional modes by which to display the data.
 - Value Column – displays the values of the parameter items.
 - Range Column – displays the minimum and the maximum limit value.
 - Unit Column – displays the unit for the parameter values.

- To change the Unit mode, tap the **Setting** button on the top toolbar and select a required mode. See [Unit](#) on page 67.

3. Display Mode

There are four types of display modes available for data viewing, allowing you to view various types of parameters in the most suitable way for better data check-ups.

Tap the drop-down button on the right side of the parameter name to open a submenu. There are 4 buttons configuring the data display mode, plus one Help button on the right, active when additional information is available for your reference.

Each parameter item displays the selected mode independently.

- ✧ **Analog Gauge Mode** – displays the parameters in form of an analog meter graph.
- ✧ **Text Mode** – the default mode that displays the parameters in texts and shows in list format.

NOTE

Reading of status parameters, such as a switch reading, which are mostly in word form, such as ON, OFF, ACTIVE, and ABORT can only be displayed in Text Mode. Whereas reading of value parameters, such as a sensor reading, can be displayed in text mode and graph modes.

- ✧ **Waveform Graph Mode** – displays the parameters in waveform graphs.

When displaying this mode, three control buttons will appear on the right side of the parameter item, allowing you to manipulate the display status.

 - Text Button – resumes Text Display Mode.
 - Scale Button – changes the scale values, which are displayed below the waveform graph. There are four scales available: x1, x2, x4 and x8.
 - Zoom-in Button – taps once to display the selected data graph in full screen.
 - ✧ **Digital Gauge Mode** – displays the parameters in form of a digital gauge graph.
 - ✧ **Full Screen Display** – this option is only available in the waveform graph mode, and mostly used in Graph Merge status for data comparison. There are three control buttons available on the top right side of the screen under this mode.
 - Edit Button – tap to open an edit window, on which you can set the waveform color and the line thickness displayed for the selected parameter.
 - Scale Button – tap to change the scale values, which are displayed below the waveform graph. There are four scales available: x1, x2, x4 and x8.
 - Zoom-out Button – tap to exit full screen display.
- **To edit the waveform color and line thickness in a data graph**
1. Select 1 to 3 parameters to display in Waveform Graph Mode.
 2. Tap the **Zoom-in Button** on the right to display the data graph in full screen.

3. Tap the **Edit Button**, an edit window appears.
 4. Select a parameter item on the left column.
 5. Select a desired sample color from the second column.
 6. Select a desired sample line thickness from the right column.
 7. Repeat steps 4-6 to edit the waveform for each parameter item.
 8. Tap **Done** to save the setting and exit, or tap **Cancel** to exit without saving.
4. Functional Buttons

The operations of all the available functional buttons on the Live Data screen are described below:

- ✧ **Back** – returns to the previous screen or exit the function.
- ✧ **Record** – starts recording the retrieved live data; the recorded data is then stored as a video clip in the Data Manager application for future reviews. This function could be triggered automatically at preset threshold value or manually as you choose, and the triggering mode and record duration can be configured in the Setting mode of Live Data.
- ✧ **Freeze** – displays the retrieved data in freeze mode.
 - Previous Frame – moves to the previous frame in the freeze data.
 - Next Frame – moves to the next frame in the freeze data.
- ✧ **Resume** – this button displays when the Record or Freeze function is applied. Tapping this button stops data recording, or exits freeze data mode, and resumes normal data display mode.
- ✧ **Flag** – this button appears when the Record function is applied. Tapping this button sets flags for the recorded data at points wherever you choose, when playing back the recorded video clip later in *Data Manager*, the preset flag will enable a popup to allow input of text to take notes.
- ✧ **Clear Data** – tap button to clear all previously retrieved parameter values at a cutting point whenever you choose.
- ✧ **To Top** – moves a selected data item to the top of the list.
- ✧ **Graph Merge** – tap button to merge selected data graphs (for Waveform Graph Mode only). This function is very useful when making comparison for different parameters.

 **NOTE**

This mode supports Graph Merge for 2 to 3 parameter items only, select no less than 2 or more than 3 items each time when making graph merge.

- To cancel Graph Merge mode, tap the drop-down button on the right side of the parameter name, and select a data display mode.
 - ✧ **Show Selected/Show All** – tap button to exchange between the two options; one displays the selected parameter items, the other displays all the available

items.

- ◇ **Setting** – tap button to open a setting screen, which allows you to set the trigger mode, recording duration, and various threshold values for data recording, and make other controls.

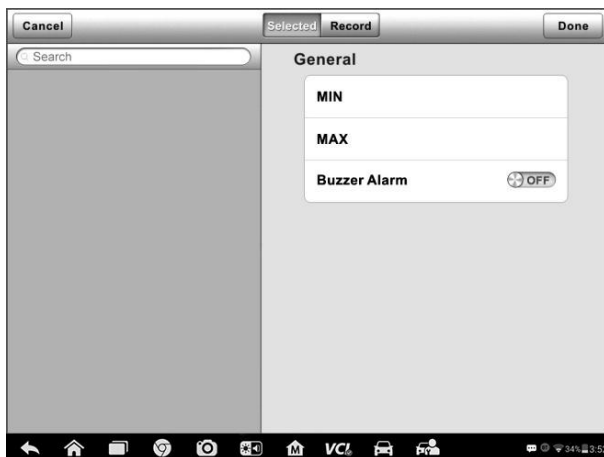

Figure 4-10 Sample Setting Mode in Live Data

There are four navigation buttons on top of the **Setting** mode screen.

- **Range** – displays the configuration screen on which you can set the threshold values, an upper limit and a lower limit, for triggering the buzzer alarm. This function is only applied to the Waveform Graph display mode.
 - a) **MIN** – tap button to open a virtual keyboard to enter the required lower limit value.
 - b) **MAX** – tap button to open a virtual keyboard to enter the required upper limit value.
 - c) **Buzzer Alarm** – switches the alarm on and off. The alarm function makes a beep sound as a reminder whenever the data reading reaches the preset minimum or maximum point.
- **To set threshold limits for the parameter values**
 1. Tap the **Setting** button at the bottom of the Live Data screen.
 2. Tap the **Range** navigation button.
 3. Select a parameter item on the left column, or enter the item name in the Search bar.
 4. Tap on the right side of the **MIN** button, and enter the required minimum value.
 5. Tap on the right side of the **MAX** button, and enter the required maximum value.
 6. Tap the **ON/OFF** button on the right side of the Buzzer Alarm button

to turn it on or off.

7. Tap **Done** to save the setting and return to the Live Data screen; or tap **Cancel** to exit without saving.

If the threshold limits are successfully set, two horizontal lines now appear on each of the data graphs (when Waveform Graph Mode is applied) to indicate the alarming point. The threshold lines are shown in different colors than the waveform of the parameters for distinction.

- **Record** – displays the configuration screen for Record Setting, on which you can set the trigger type, duration and trigger point for the data recording function.
 - a) **Trigger Type** – sets the trigger mode for data recording, mainly of two kinds: Manual and Auto. There are four options available:
 - 1) **Manual** – allows you to manually start and stop data recording.
 - 2) **DTC** – auto triggers data recording when any DTC is detected.
 - 3) **DTC Check Mode** – auto triggers data recording when certain pre-selected DTC types are detected.
 - 4) **Parameter** – auto triggers data recording when any parameter value reaches the preset threshold.
 - b) **Duration** – sets the recording time (for Auto trigger mode only).
 - c) **Trigger Point** – reserves a relative percentage of a record length before the data recording start point for reference (for Auto trigger mode only).

➤ **To perform setting for live data record**

1. Tap the **Setting** functional button at the bottom of the Live Data screen.
 2. Tap the **Record** navigation button.
 3. Tap the > button on the right of **Trigger Type** bar and select the required trigger mode.
 4. Tap the > button on the right of **Duration** bar and select a length of time.
 5. Tap the > button on the right of **Trigger Point** bar and select a relative percentage of a record length to be reserved before the data recording start point.
 6. Tap **Done** to save the setting and return to the Live Data screen; or tap **Cancel** to cancel without saving and exit Setting.
- **Done** – confirms and saves the setting, and returns you to the Live Data screen.
 - **Cancel** – cancels the setting operation, and returns you to the Live Data screen.

Active Test

The Active Test function is used to access vehicle-specific subsystem and component tests. Available test vary by vehicle manufacturer, year, and model, and only the available tests display in the menu.

During an active test, the tester outputs commands to the ECU in order to drive the actuators. This test determines the integrity of the system or parts by reading the engine ECU data, or by monitoring the operation of the actuators, such as switching a solenoid, relay, or switch, between two operating states.

Selecting Active Test opens a menu of test options that varies by vehicle make and model. Selecting a menu option activates the test. Follow all screen instructions while performing tests. How and what information is presented on the screen varies according to the type of test being performed. Some toggle and variable control tests display Active Test Controls at the top of the screen with data stream information below, or vice versa.

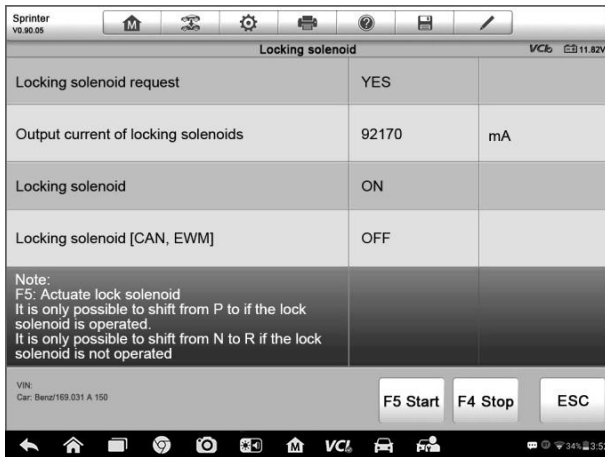

Figure 4-11 Sample Active Test Screen

The functional buttons at the lower right corner of the Active Test screen manipulate the test signals. The operational instructions are displayed on the main section of the test screen. Simply follow the on-screen instructions and make appropriate selections to complete the tests. Each time when an operation is successfully executed, message such as “Command Finished”, “Activation Successful”, or something similar displays.

Tap the **ESC** functional button to exit the test when finished.

Special Functions

These functions perform various component adaptations, allowing you to recalibrate or configure certain components after making repairs or replacement.

The main section of the Adaptation Operation screen displays a list of operational and vehicle status information, which mainly consists of four parts:

1. The first part in the top line shows the description of the operation being performed, and the execution status is displayed on the right, such as Completed, or Activated.
2. The second part shows the preconditions or requirements for executing the operation being selected.
3. The third part displays the current conditions of the vehicle control module being learned for comparison to the preconditions suggested by the second part. If the current condition of the control module is out of the suggested limit value, you must adjust the vehicle condition to meet the requirement.
4. The last part displays the instruction of how to use the functional button at the lower right corner of the screen to manipulate the teach-in operations.

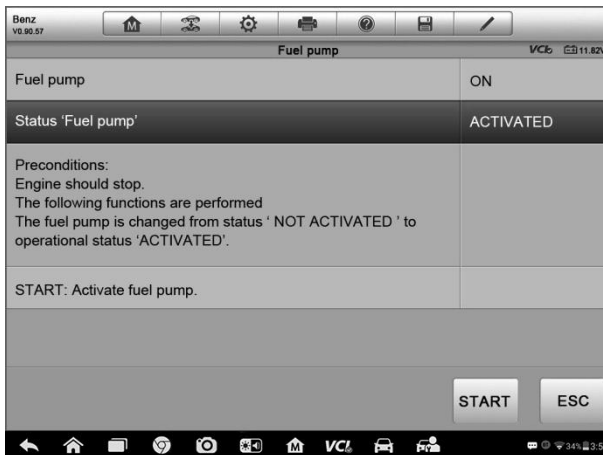

Figure 4-12 Sample Adaptation Operation Screen

Read the information carefully and check the vehicle condition accordingly, when you are sure that the vehicle is ready to perform the adaptation, simply follow the instructions provided to make appropriate selections. When the operation is done, an execution status message such as Completed, Finished or Successful, displays.

Tap the **ESC** button to exit the function.

Generic OBD II Operations

A fast-access option for OBD II/E OBD vehicle diagnosis is available on the Vehicle Menu screen. This option presents a quick way to check for DTCs, isolate the cause of an illuminated malfunction indicator lamp (MIL), check monitor status prior to emissions certification testing, verify repairs, and perform a number of other services that are

emissions-related. The OBD direct access option is also used for testing OBD II/EOBD compliant vehicles that are not included in the Diagnostics database. Functions of the diagnostics toolbar buttons at the top of the screen are the same as those available for specific vehicle diagnostics. See [Table 4-2 Diagnostics Toolbar Buttons](#) on page 22 for details.

General Procedure

➤ To access the OBD II/EOBD diagnostics functions

1. Tap the **Diagnostics** application button from the MaxiSys Job Menu. The Vehicle Menu displays.
2. Tap the **EOBD** button. There are two options to establish communication with the vehicle.
 - Auto Scan – select it to establish communication using each protocol in order to determine which one the vehicle is broadcasting on.
 - Protocol – select it to open a submenu of various protocols. A communication protocol is a standardized way of data communication between an ECM and a diagnostic tool. Global OBD may use several different communication protocols.
3. Select a specific protocol if the **Protocol** option is selected. Wait for the OBD II Diagnostic Menu to appear.



Figure 4-13 Sample OBD II Diagnostic Menu

NOTE

Tap the **i** button beside the protocol name to display additional protocol information.

4. Select a function option to continue.
 - DTC & FFD

- I/M Readiness
- Live Data
- O2 Sensor Monitor
- On-Board Monitor
- Component Test
- Vehicle Information
- Vehicle Status

NOTE

Some functions are supported only on certain vehicles.

Function Descriptions

This section describes the various functions of each diagnostic option:

DTC & FFD

When this function is selected, the screen displays a list of Stored Codes and Pending Codes. When the Freeze Frame data of certain DTCs are available for viewing, a snowflake button will display on the right side of the DTC item. The Erase Codes function can be applied by tapping the functional button at the lower bottom of the screen.

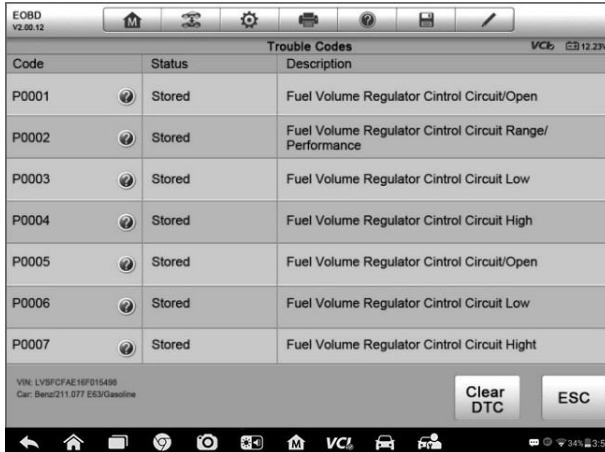

Figure 4-14 Sample DTC & FFD Screen

- **Stored Codes**

Stored codes are the current emission related DTCs from the ECM of the vehicle. OBD II/EOBD Codes have a priority according to their emission severity, with higher priority codes overwriting lower priority codes. The priority of the code determines the illumination of the Malfunction Indicator Light (MIL) and the codes

erase procedure. Manufacturers rank codes differently, so expect to see differences between vehicles.

- **Pending Codes**

These are codes whose setting conditions were met during the last drive cycle, but need to be met on two or more consecutive drive cycles before the DTC actually sets. The intended use of this service is to assist the service technician after a vehicle repair and after clearing diagnostic information, by reporting test results after a single driving cycle.

- a) If a test failed during the driving cycle, the DTC associated with that test is reported. If the pending fault does not occur again within 40 to 80 warm-up cycles, the fault is automatically cleared from memory.
- b) Test results reported by this service do not necessarily indicate a faulty component or system. If test results indicate another failure after additional driving, then a DTC is set to indicate a faulty component or system, and the MIL is illuminated.

- **Freeze Frame**

In most cases the stored frame is the last DTC that occurred. Certain DTCs, those that have a greater impact on vehicle emission, have a higher priority. In these cases, the highest priority DTC is the one for which the freeze frame records are retained. Freeze frame data includes a “snapshot” of critical parameter values at the time the DTC is set.

- **Erase Codes**

This option is used to clear all emission related diagnostic data such as, DTCs, freeze frame data and manufacturer specific enhanced data from the vehicle’s ECM, and resets the I/M Readiness Monitor Status for all vehicle monitors to Not Ready or Not Complete status.

A confirmation screen displays when the clear codes option is selected to prevent accidental loss of data. Select **Yes** on the confirmation screen to continue, or **No** to exit.

I/M Readiness

This function is used to check the readiness of the monitoring system. It is an excellent function to use prior to having a vehicle inspected for compliance to a state emissions program. Selecting I/M Readiness opens a submenu with two choices:

- Since DTCs Cleared – displays the status of monitors since the last time the DTCs are erased.
- This Driving Cycle – displays the status of monitors since the beginning of the current drive cycle.

Live Data

This function displays the real time PID data from ECU. Displayed data includes analog inputs and outputs, digital inputs and outputs, and system status information broadcast on the vehicle data stream.

Live data can be displayed in various modes, see [Live Data](#) on page 31 for detailed information.

O2 Sensor Monitor

This option allows retrieval and viewing of O2 sensor monitor test results for the most recently performed tests from the vehicle's on-board computer.

The O2 Sensor Monitor test function is not supported by vehicles that communicate using a controller area network (CAN). For O2 Sensor Monitor tests results of CAN-equipped vehicles, refer to [On-Board Monitor](#).

On-Board Monitor

This option allows you to view the results of On-Board Monitor tests. The tests are useful after servicing or after erasing a vehicle's control module memory.

Component Test

This service enables bi-directional control of the ECM so that the diagnostic tool is able to transmit control commands to operate the vehicle systems. This function is useful in determining how well the ECM responds to a command.

Vehicle Information

The option displays the vehicle identification number (VIN), the calibration identification, and the calibration verification number (CVN), and other information of the test vehicle.

Vehicle Status

This item is used to check the current condition of the vehicle, including communication protocols of OBD II modules, retrieved codes amount, status of the Malfunction Indicator Light (MIL), and other additional information may be displayed.

Exit Diagnostics

The Diagnostics application remains open as long as there is an active communication with the vehicle. You must exit the diagnostics operation interface to stop all communications with the vehicle before closing the Diagnostics application.

NOTE

Damage to the vehicle electronic control module (ECM) may occur if communication is disrupted. Make sure the all connections, such as data cable, USB cable, and wireless

or wired network, are properly connected at all times during testing. Exit all tests before disconnecting the test cable or powering down the tool.

➤ **To exit the Diagnostics application**

1. From an active diagnostic screen, tap the **Back** or **ESC** functional button to exit a diagnostic session step-by-step; Or
2. Tap the **Vehicle Swap** button on the diagnostics toolbar to return to the Vehicle Menu screen.
3. From the vehicle menu screen, tap the **Home** button on the top toolbar; or tap the **Back** button on the navigation bar at the bottom of the screen. Or
4. Tap the **Home** button on the diagnostics toolbar to exit the application directly to the MaxiSys Job Menu.

Now, the Diagnostics application is no longer communicating with the vehicle and it is safe to open other MaxiSys applications, or exit the MaxiSys Diagnostic System and return to the Android System's Home screen.

5 Service

The **Service** section is specially designed to provide quick access to the vehicle systems for various scheduled service and maintenance tasks. The typical service operation screen is a series of menu driven executive commands. Follow on-screen instructions to select appropriate execution options, enter correct values or data, and perform necessary actions. The application will display detailed instructions to complete selected service operations.

After entering each special function, the screen will display two application choices: **Diagnosis** and **Hot Functions**. The **Diagnosis** enables the reading and clearing of codes which is sometimes necessary after completing certain special functions. **Hot Functions** consists of sub functions of the selected special function.



Figure 5-1 Sample Service Menu

Several most commonly used services are described in this chapter.

Oil Reset Service

Perform reset for the Engine Oil Life system, which calculates an optimal oil life change interval depending on the vehicle driving conditions and climate. The Oil Life Reminder must be reset each time the oil is changed, so the system can calculate when the next oil change is required.

NOTE

1. Always reset the engine oil life to 100% after every oil change.

2. All required work must be carried out before the service indicators are reset. Failure to do so may result in incorrect service values and cause DTCs to be stored by the relevant control module.
 3. For some vehicles, the scan tool can reset additional service lights such as maintenance cycle and service interval. On BMW vehicles for example, service resets include engine oil, spark plugs, front/rear brakes, coolant, particle filter, brake fluid, micro filter, vehicle inspection, exhaust emission inspection and vehicle checks.
-

Electric Parking Brake (EPB) Service

This function has a multitude of usages to maintain the electronic braking system safely and effectively. The applications include deactivating and activating the brake control system, assisting with brake fluid control, opening and closing brake pads, and setting brakes after disc or pad replacement.

EPB Safety

It can be dangerous to perform Electric Parking Brake (EPB) system maintenance, so before you begin the service work, please keep these rules in mind.

- ✓ Ensure that you are fully familiar with the braking system and its operation before commencing any work.
- ✓ The EPB control system may be required to be deactivated before carrying out any maintenance/diagnostic work on the brake system. This can be done from the tool menu.
- ✓ Only perform maintenance work when the vehicle is stationary and on level ground.
- ✓ Ensure that the EPB control system is reactivated after the maintenance work has been completed.

NOTE

Autel accepts no responsibility for any accident or injury arising from the maintenance of the Electric Parking Brake system.

Tire Pressure Monitoring System (TPMS) Service

This function allows you to quickly look up the tire sensor IDs from the vehicle's ECU, as well as to perform TPMS replacement and reset procedures after tire sensors are replaced.

Battery Management System (BMS) Service

The Battery Management System (BMS) allows the tool to evaluate the battery charge state, monitor the close-circuit current, register the battery replacement, activate the rest state of the vehicle, and charge the battery via the diagnostic socket.

NOTE

1. This function is not supported by all vehicles.
2. The sub functions and actual test screens of the BMS may vary by vehicle, please follow the on-screen instructions to make correct option selection.

The vehicle may use either a sealed lead-acid battery or an AGM (Absorbed Glass Mat) battery. Lead acid battery contains liquid sulphuric acid and can spill when overturned. AGM battery (known as VRLA battery, valve regulated lead acid) also contains sulphuric acid, but the acid is contained in glass mats between terminal plates.

It is recommended that the replacement aftermarket battery has the same specifications, such as capacity and type, as the exiting battery. If the original battery is replaced with a different type of battery (e.g. a lead-acid battery is replaced with an AGM battery) or a battery with a different capacity (mAh), the vehicle may require reprogramming of the new battery type, in addition to, performing the battery reset. Consult the vehicle manual for additional vehicle-specific information.

Steering Angle Sensor (SAS) Service

Steering Angle Sensor Calibration permanently stores the current steering wheel position as the straight-ahead position in the steering angle sensor EEPROM. Therefore, the front wheels and the steering wheel must be set exactly to the straight-ahead position before calibration. In addition, the vehicle identification number (VIN) is also read from the instrument cluster and stored permanently in the steering angle sensor EEPROM. On successful completion of calibration, the steering angle sensor fault memory is automatically cleared.

Calibration must always be carried out after the following operations:

- Steering wheel replacement
- Steering angle sensor replacement
- Any maintenance that involves opening the connector hub from the steering angle sensor to the column
- Any maintenance or repair work on the steering linkage, steering gear or other related mechanism
- Wheel alignment or wheel track adjustment
- Accident repairs where damage to the steering angle sensor or assembly, or any part of the steering system may have occurred

 **NOTE**

1. Autel accepts no responsibility for any accident or injury arising from servicing the SAS system. When interpreting DTCs retrieved from the vehicle, always follow the manufacturer's recommendation for repair.
 2. All software screens shown in this manual are examples, actual test screens may vary by test vehicle. Pay attention to the menu titles and onscreen instructions to make correct option selections.
 3. Before starting procedure, make sure vehicle has an ESC button. Look for button on dash.
-

Diesel Particle Filter (DPF) Service

The Diesel Particle Filter (DPF) function manages DPF regeneration, DPF component replacement teach-in and DPF teach-in after replacing the engine control unit.

The ECM monitors driving style and selects a suitable time to employ regeneration. Cars driven a lot at idling speed and low load will attempt to regenerate earlier than cars driven more with higher load and speed. In order for regeneration to take place, a prolonged high exhaust temperature must be obtained.

In the event of the car being driven in such a way that regeneration is not possible, i.e., frequent short journeys, a diagnostic trouble code will eventually be registered in addition to the DPF light and "Check Engine" indicators displaying. A service regeneration can be requested in the workshop using the diagnostic tool.

Before performing a forced DPF regeneration using the tool, check the following items:

- The fuel light is not on.
- No DPF-relevant faults are stored in system.
- The vehicle has the specified engine oil.
- The oil for diesel is not contaminated.

 **IMPORTANT**

Before diagnosing a problem vehicle and attempting to perform an emergency regeneration, it is important to obtain a full diagnostic log and read out relevant measured value blocks.

 **NOTE**

1. The DPF will not regenerate if the engine management light is on, or there is a faulty EGR valve.
2. The ECU must be re-adapted when replacing the DPF and when topping up the fuel additive Eolys.

3. If the vehicle needs to be driven in order to perform a DPF service, a second person is needed for the function. One person should drive the vehicle while the other person observes the screen on the Tool. Do not attempt to drive and observe the scan tool at the same time. This is dangerous and puts your life and the lives of other motorists and pedestrians at risk.
-

Immobilizer (IMMO) Service

An immobilizer is an anti-theft mechanism that prevents an automobile's engine from starting unless the correct ignition key or other device is present. This device prevents thieves from starting the car by a method known as hot wiring. Most new vehicles have an immobilizer as standard equipment. An important advantage of this system is that it doesn't require the car owner to activate it; it operates automatically. An immobilizer is considered as providing much more effective anti-theft protection than an audible alarm alone; many auto insurance companies offer lower rates for vehicles that are equipped with an immobilizer.

As an anti-theft device, an immobilizer disables one of the systems needed to start a car's engine, usually the fuel supply or the ignition. This is accomplished by radio frequency identification between a transponder in the ignition key and a device called a radio frequency reader in the steering column. When the key is placed in the ignition, the transponder sends a signal with a unique identification code to the reader, which relays it to a receiver in the vehicle's computer control module. If the code is correct, the computer allows the fuel supply and ignition systems to operate and start the car. If the code is incorrect or absent, the computer disables the system, and the car will be unable to start until the correct key is placed in the ignition.

The IMMO service can disable a lost vehicle key and program the replacement key fob. One or more replacement key fobs can be programmed.

6 MaxiFix

The MaxiFix application launches the online troubleshooter database, which not only provides you virtually all common diagnostic trouble code (DTC) database for most vehicles, but also serves as a forum allowing you to network with other MaxiSys users, and gives you access to a vast database of repair and diagnostic tips along with proven fixes.

While the MaxiFix provides the abundant troubleshooter information available, the database keeps growing with daily troubleshooting resources by recording the reported solution cases, and the advisory reports of the MaxiSys users from all over the world.

Information in the MaxiFix database is organized into a series of diagnostic tips that are designed to quickly lead you to the root cause of a particular problem on the test vehicle, which will help you quickly find solutions for various diagnostic problems.

Navigation

You need to register the device to your online account before launching the MaxiFix platform, see [Product Registration](#) on page 78 for details.



Figure 6-1 Sample MaxiFix Home Page

The MaxiFix screen layout consists of three main areas:

1. The Header – the tool bar across the top of the screen which allows you to select vehicles and perform searches.

2. The Main Screen – located at the center of the screen displaying content based on the vehicle attributes and keywords specified. The tabs on the main screen vary in accordance with the section selected on the Navigation Menu, allowing you to switch between functions.
3. The Navigation Menu – the main menu at the bottom of the screen, which provides you access to different sections of MaxiFix.

The Header

The Header at the top of the screen, features:

- A Select Vehicle button to open the vehicle identification window, and vehicle information bar, for example “2014>Hyundai> Accord Coupe > L4-2.4L (K24W1)”.
- A search field to find relevant information by entering keywords, codes, or problems.

Select Vehicle Button

The “Select Vehicle” button on the Header allows you to specify the vehicle that you want to reference on MaxiFix, by selecting each of the vehicle attribute from a sequence of option lists. This feature helps to filter out the searches that allow only the information that applies to the identified vehicle to display.

NOTE

All attributes must be specified to make a complete vehicle selection for the most efficient search results.

➤ **To select a vehicle**

Follow the procedure below to select a vehicle:

1. If you haven't already done so, click the “Select Vehicle” button on the Header.
2. Select the **year** of the vehicle from the list.
3. Select the **make** of the vehicle from the list.
4. Select the **model** of the vehicle from the list.
5. Select the **submodel** of the vehicle from the list.
6. Select the **engine** of the vehicle from the list.

After completing the vehicle selection procedure, the identified vehicle is shown on the Header.

Terminology

MaxiFix Tip

A MaxiFix Tip provides practical information of a real fix of a specific vehicle repair issue with detailed descriptions. It is combined with proven fix and vehicle specific data, and filed into an all-in-one information source to provide you with quick and easy repair solutions.

On MaxiFix community you can find Tips or share your own Tip to help other community members solve vehicle issues.

➤ **To search for a MaxiFix Tip**

1. Select a Vehicle.
 - a) Click the “Select Vehicle” button on the Header at the top of the page.
 - b) Select the **year** of the vehicle from the list.
 - c) Select the **make** of the vehicle from the list.
 - d) Select the **model** of the vehicle from the list.
 - e) Select the **submodel** of the vehicle from the list.
 - f) Select the **engine** of the vehicle from the list.

After completing the vehicle selection procedure, the identified vehicle is shown on the Header.

2. Enter a Search Term.

MaxiFix has an exclusive one-stop lookup that helps you find all of MaxiFix resources by one click. Simply enter a search term into the search bar on the Header to begin the search.

3. Proven Results!

The powerful MaxiFix database gives you proven results! The typical MaxiFix Tips combine actual workshop fixes and data that may include:

- a) OBDII Fault Codes description and reference – helps in diagnostic assessment by making clear the nature of an automotive problem so that beginner and advanced technicians can make effective repairs.
- b) Real Fix Tips – provides repair tips from actual shop practices and are presented in an easy to understand Complaint, Cause, Correction format.

If you still can't find the information you want, you can ask the MaxiFix community for help by clicking “Ask” on the Navigation Menu at the bottom of the screen.

Adopted!

The “Adopted!” icon that displays at the top right side of a Tip page indicates that the related Tip has been adopted by at least one technician in the community. If a tip has helped you to solve a repair problem, you are encouraged to give an Adopted! count to the tip. The “Adopted!” count helps you easily identify the tips are really helpful for repairing vehicle issues. You can also post a comment about how the tip has helped you as reference to other members.

Operations

The Navigation Menu is at the bottom of the screen. Selecting the items on the Navigation Menu allows you to switch between the main sections on MaxiFix. These main sections include:

- Home – displays all questions posed and allows you to enter your specific question about one or multiple vehicle makes.
- Search Fix – allows you to search for information from all available resources on MaxiFix, including: Open Questions, Tips, and Real Fixes, and displays search results.
- Ask – allows you to ask a question to the community.
- My MaxiFix – displays all your posts including Questions and Fixes in the community, and allows you to view your personal profile, select your vehicle preference, and share your tips.
- My Messages – displays a list of message notifications relevant to your activities in the Question section.
- Support – opens the FAQ page, or a message box for contacting Customer Service by email.

Home

At the bottom of the screen, Home is the first option on the Navigation Menu. Tap to open your MaxiFix home page. There is a list of questions posted on the community, and you can scroll down the page to the bottom and view more questions by tapping “View More”. Click on any question and you will be linked to the detailed page in the Ask section.

You can configure your main screen to display questions only related to the vehicle makes you are interested in, by clicking the “Filter” button on the main page of Home, and select the desired vehicle makes. This filter can be canceled anytime by clicking the “Remove All Filters” button, and the default setting will be restored to display questions about all vehicle makes.

Search Fix Features

Search Fix, the second option on the Navigation Menu at the bottom of the screen, presents search results for the specified vehicle. Search results are listed in various categories:

- All – includes all search results, including related Questions, Tips, and Real Fixes to your search.
- Questions – presents a list of open Question discussed in the community that may be pertinent to your search.
- Tips – presents a list of Tips that directly correlate to your search criteria. Select a Tip from the list to open and review the complete Tip.
- Real Fixes – presents a list of Tips that have been collected from actual shop repair orders and are presented in an easy-to-understand Complaint, Cause, and Correction format.

Ask

Ask, the third option on the Navigation Menu at the bottom of the screen, allows you to ask a question about a particular vehicle repair issue in the community.

➤ To ask a MaxiFix Question

1. If not already done, click **Select Vehicle** on the Header to specify the vehicle you are asking about.
2. Click **Ask** on the Navigation Menu at the bottom of the screen to open the Ask page.
3. On the **Ask** page find **Ask for Help**, fill in the following sections to ask a question.

The Ask page has four sections:

- Subject – this is where you enter a brief subject for the question.
- My Question – asks a clear and concise question that you want to ask the community. Be sure to be descriptive and concise when asking your question.
- Problem Description – describes how the vehicle is behaving.
- Repair History – includes any previous diagnostic tests that you performed, including the results of the tests. Also list any parts that were replaced during previous diagnostic work.

Tap the “Cancel” button to cancel your question and return to the Ask page

Tap the “Submit” button to post your question to the community.

Tap the “Attach File” button to include images or reference files with your question.

You are requested to select one Adopted Answer from all of the responses and then close the question. For details, please refer to My Messages section.

My MaxiFix

My MaxiFix, the fourth option on the Navigation Menu at the bottom of the screen, opens your personal MaxiFix page. To access the features on My MaxiFix page you can select from the tabs:

- My Questions – opens a list with links to the opened questions that you have posted to the community
- My Cases – opens a list with links to the closed questions and tips that you have contributed to the community.
- Marked Posts – opens a list with links to Tips and discussions that you are actively participating in.
- My Profile – allows you to view your Autel account information including: your Autel ID, personal information, MaxiFix score, phone number and register time, and edit your portrait.
- Vehicle Preference – used to set up a list of preferred vehicles. The preferred list allows you to limit the choices that displayed on the “Select Vehicle” list to specific years, and makes. Click “Set Year” or “Set Make” to set your preferred models. The preferred makes will also be displayed in the “Filter” options on the Home page.
- Share a Tip – allows you to share your personal repair experience with the community.

Click **My MaxiFix** on the Navigation Menu at the bottom of the screen, to display all questions and tips that you have contributed to the community.

Create a Tip

A “Tip” is a concise and complete description of the fix for a particular vehicle repair issue.

➤ **To create a new MaxiFix Tip**

1. Select **My MaxiFix** from the Navigation Menu.
2. Select **Select Vehicle** from the Header and enter the identifying attributes of the vehicle you are writing the Tip about.
3. On the My MaxiFix page find **Share a Tip**; click this link to open the **My Tips** page.
4. Enter the Tip subject in the **Subject** field.
5. Compose your Tip in the **Description** field. Include as much information as possible, while keeping the information concise and to the point. A Tip should provide accurate information that is reader-friendly.

Use the **Cancel** button at the right-side bottom of the page to cancel your tip and return to the My MaxiFix page. Or,

Use the **Submit** button at the right-side bottom of the page to contribute your tip to the community.

Use the **Attach File** button at the left-side bottom of the page to include images or other supporting data with your question.

View Profile Information

You can view your personal profile by clicking on your account ID or “My Profile” in My MaxiFix section or edit portrait where applicable, and visit other community members’ profile by clicking their portrait. Information included in your profile determines how you are presented to the community, and what type of information will be sent to you from the community.

My Messages

My Messages, the fifth option on the Navigation Menu at the bottom of the screen, shows a list of message notification which is relevant to your activities in the Question section. A notification icon will appear on the top-right corner of “My Messages” if there is any new or unread message in the Question section. The number on the notification icon indicates the total number of the new and unread messages. The displayed number will be reduced correspondingly after viewing. The message notification will appear under the following two conditions:

1. Your question or answer is replied by other MaxiFix community members.
2. Your answer is marked as the “Adopted!” by the MaxiFix community member who asked the question.

Tap **My Messages**, select and open the message you want to read from the list. If your problem is solved according to the reply, you should select one Adopted Answer and close the question. If your answer is marked as “Adopted!”, the prompt “Adopted! + 4” will be displayed permanently.

Tap **Clear** to delete all message notifications.

Select “Adopted Answers”

Members are requested to select one Adopted Answer from all of the responses on “My Messages” page before closing a question. The community members who provided the Adopted Answer are rewarded with scores for their contribution.

About Adopted Answer:

- Only one answer can be selected as “Adopted Answer”.

- Answers can only be rated by the MaxiFix member who asked the question.

Close a Question

When a repair question that you've posted to the community is resolved, you are encouraged to write down the case as a way to share a good solution. This will help the other MaxiFix members to find useful information for practical fix.

To close a question, you need to select the question's response message from the message list on "My Messages" page first, then tap "Adopted Answer" and select "Close Question". Tap the "Cancel" button to cancel your submission and return to My Messages page. It is strongly recommended to share your repair solutions before closing a question. Your question will be converted to a MaxiFix Community Tip after closing.

Score Rewarding System

1. A score of 4 is awarded if your answer is selected as the "Adopted Answer".
2. A score of 3 is awarded when you close a question.
3. A score of 2 is awarded if your closed question is marked as "Adopted!" by no less than 20 community members.
4. A score of 1 is awarded if your answer is selected as the "Adopted Answer" for a closed question that is marked as "Adopted!" by no less than 20 community members.
5. A score of 1 is awarded to each of the first three respondents.

Support

Support, the last option on the Navigation at the bottom of the screen, opens a page that provides two ways to gain support from MaxiFix:

1. A message form to contact the administrator of MaxiFix.
2. A Frequently Asked Questions (FAQ) link that answers the most frequent questions we hear from MaxiFix community members.

If you wish to contact the administrator of this site please use the contact form. Select "Support" from the Navigation Menu to open the comment window. To allow the administrator to respond to your question or issue, the following information should be provided:

- Your name
- A contact email address
- A contact phone number











7 Shop Manager

The Shop Manager application helps you manage the workshop information, customer information records, and keep test vehicle history records, which can help in dealing with daily workshop business and improves customer service. There are three main functions available:

- **Vehicle History**
- **Workshop Information**
- **Customer Manager**

The operations of these functions of the Shop Manager application are mainly manipulated by the toolbar buttons, which are listed and described in the table below:

Table 7-1 Top Toolbar Buttons in Shop Manager

Name	Button	Description
Back		Return to the previous screen.
Diagnostics		Tap to display the Diagnostics screen to activate a direct test session.
Enter Edit		Tap to display the editing toolbar to print or delete the selected file.
Delete		Tap to delete the selected vehicle record item from the list.
Search		Quickly locates the vehicle record by entering the vehicle name or test path.
Cancel		Tap to cancel edit or file search.
Edit		Tap to edit information for the displayed file.
Add Account		Tap to create a new customer account file.
History Notes		Tap to open a note form, which allows you to create audio record, attach picture or video, or edit text notes.
Vehicle History		Tap to open the Vehicle History screen that displays the correlated test vehicle records.
Done		Save the file when complete editing.

Vehicle History

This function stores records of test vehicle history, including vehicle information and the retrieved DTCs from previous diagnostic sessions. Test information is summarized and displayed in an easy-to-view table listing. The Vehicle History also provides direct access to the previously tested vehicle and allows you to restart a diagnostic session without the need to do vehicle identification again.

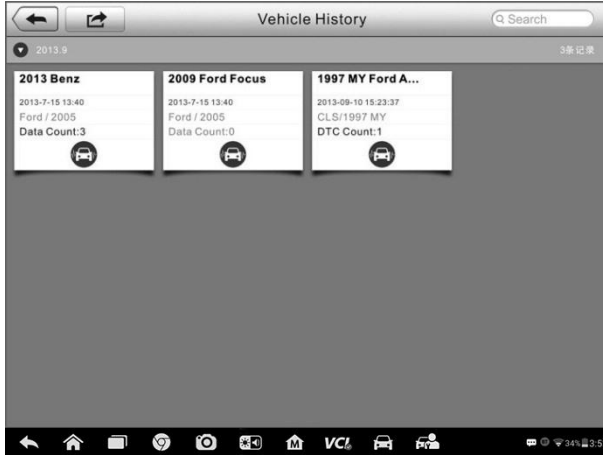

Figure 7-1 Sample Vehicle History Screen

1. Top Toolbar Buttons – navigation and application controls.
2. Main Section – displays all the vehicle history records.
- **To activate a test session for the recorded vehicle**
 1. Tap **Shop Manager** on the MaxiSys Job Menu.
 2. Select **Vehicle History**.
 3. Tap **Diagnostics** at the bottom of the thumbnail of a vehicle record item. Or,
 4. Select a vehicle record item by tapping the thumbnail.
 5. A Historical Test record sheet displays, check the recorded information of the recorded test vehicle, and tap the Diagnostics button on the upper right corner.
 6. The vehicle's Diagnostics screen displays and a new diagnostic session is activated, see [Diagnosis](#) on page 25 for detailed instructions on vehicle diagnostic operations.

Historical Test Record

The Historical Test record of the tested vehicle is a detailed data form, which includes all general information of the vehicle such as vehicle year, make and model and the diagnostic trouble codes retrieved from the previous test sessions, as well as other service details that can be added manually by the technician himself.

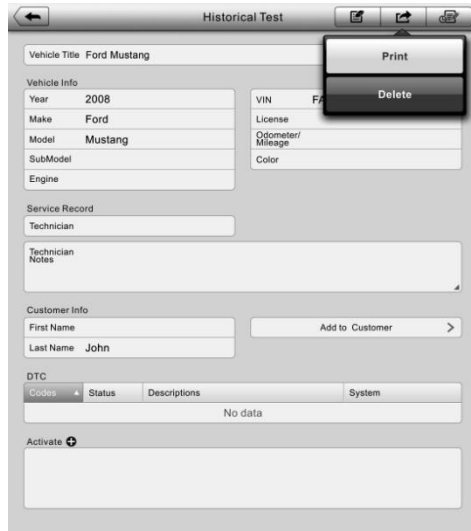

Figure 7-2 Sample Historical Test Record Sheet

➤ **To edit the Historical Test record**

1. Tap **Shop Manager** on the MaxiSys Job Menu.
2. Select **Vehicle History**.
3. Select the specific vehicle history record thumbnail from the main section. The Historical Test record will display.
4. Tap **Edit** to start editing.
5. Tap on each item to input information or attach files or images.

🕒 **NOTE**

The vehicle VIN number, license number or customer account information are correlated by default. Adding one of these IDs will automatically be associated with the other ID on the test record.

6. Tap **Add to Customer** to correlate the Historical Test record sheet to an existing customer account, or add a new associated account to be correlated with the test vehicle record. See [Customer Manager](#) on page 59 for more information.
7. Tap **Done** to save the updated record, or tap **Cancel** to exit without saving.

Workshop Information

The Workshop Information form allows you to input, edit, and save the detailed workshop information, such as shop name, address, phone number and other remarks, which, when printing vehicle diagnostic reports and other associated test file, will display as the header of the printed documents.



Figure 7-3 Sample Workshop Information Sheet

- **To edit the Workshop Information sheet**
 1. Tap the **Shop Manager** application on the MaxiSys Job Menu.
 2. Select **Workshop Information**.
 3. Tap the **Edit** button on the top toolbar.
 4. Tap on each field to input the appropriate information.
 5. Tap **Done** to save the updated workshop information record, or tap **Cancel** to exit without saving.

Customer Manager

The Customer Manager function allows you to create and edit customer accounts. It helps you to save and organize all customer information accounts that are correlated with the associated test vehicle history records.

- **To create a customer account**
 1. Tap the **Shop Manager** application on the MaxiSys Job Menu.
 2. Select **Customer Manager**.
 3. Tap the **Add Account** button. An empty information form displays, tap each field to input the appropriate information.

 **NOTE**

The items that must be filled are indicated as required fields.

4. Tap the **+** photo frame beside the Name chart to add a photo. A sub menu displays, select **Take Photo** to take a new photo for the account, or select **Choose Photo** to choose from the existing files.
5. Some customers may have more than one vehicle for service; you can always add new vehicle information to the account. Tap **Add New Vehicle Information**, and then fill in the vehicle information. Tap the **✖** button to cancel.
6. Tap **Done** to save the account, or tap **Cancel** to exit without saving.

➤ **To edit a customer account**

1. Tap **Shop Manager** on the MaxiSys Job Menu.
2. Select **Customer Manager**.
3. Select a customer account by tapping the corresponding name card. A Customer Information will display.
4. Tap **Edit** on the top toolbar to start editing.
5. Tap on the input field to edit or amend information, and enter updated information.
6. Tap **Done** to save the updated information, or tap **Cancel** to exit without saving.

➤ **To delete a customer account**

1. Tap **Shop Manager** on the MaxiSys Job Menu.
2. Select **Customer Manager**.
3. Select a customer account by tapping the corresponding name card. A Customer Information record displays.
4. Tap **Edit** on the top toolbar to start editing.
5. Tap **Delete Customer Information**. A confirmation message displays.
6. Tap **OK** to confirm the command, and the account is deleted. Tap **Cancel** to cancel the request.

History Notes

The History Notes function allows you to add audio and video records, text notes and photos, for the associated customer account, helpful when dealing with repeat customers. The note-keeping function is a good method to organize customer and vehicle data. This option will display once a customer record is filed.

➤ **To access History Notes**

1. Tap **Shop Manager** on the MaxiSys Job Menu.
2. Select **Customer Manager** or **Vehicle History**.









3. Select a customer account by tapping the corresponding name card. A Customer Information sheet displays (if **Customer Manager** is selected). Or, select a vehicle history record to open the Historical vehicle record (if **Vehicle History** is selected).
4. Tap the **History Notes** button on the top bar. The History Notes screen displays.





Figure 7-4 Sample History Notes Screen

1. Functional Buttons – navigation and function controls.
2. Main Section – displays the note list on the left column and the detail information of the selected note on the right column.

Table 7-2 Function Buttons in History Notes

Name	Button	Description
Back		Return to the previous screen.
Delete		Tap to delete the selected note.
Search		Quickly locate a note by entering the related text.
Cancel		Tap to cancel edit or file search.
Edit		Tap to open an edit window to edit notes and attach files.
Add Notes		Tap to add new note in History Notes.
Audio Record		Tap to start audio recording.
Add Photos		Tap to locate and add image to History Notes.

Name	Button	Description
Take a Video		Tap to record a video and add the file to History Notes.
Take a Photo		Take a photo and add the file to History Notes.
Save		Save notes.

➤ **To add a note in History Notes**

1. Access History Notes.
2. Tap **Add Notes**. An edit window displays.
3. Tap on the Title bar to input a note title.
4. Tap on the blank space below to edit a text note or remark.
5. Select a function button on the top to add files in any form you choose.
6. Tap **Save** to save the note; tap **Discard** or **Cancel** to exit without saving.

8 Data Manager

The Data Manager application is used to store, print, and review the saved files. Most operations are controlled through the toolbar.

Selecting the Data Manager application opens the file system menu. Different file types are sorted separately under different options.

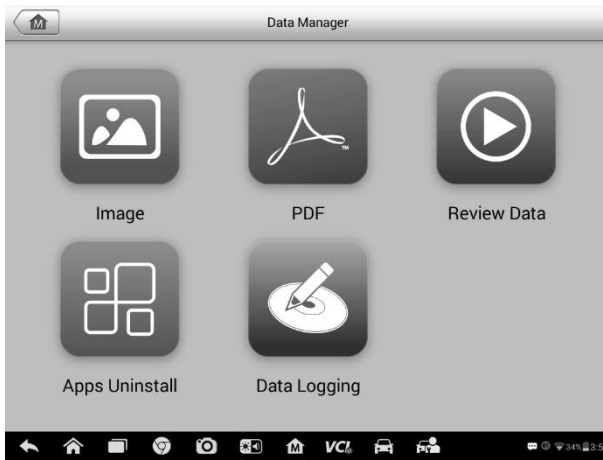

Figure 8-1 Sample Data Manager Main Screen

Operations

Data Manager Operations are based on toolbar controls, details are explained in the following sections.

Image Files







The Image section is a JPG database containing all captured screenshot images.



Figure 8-2 Sample Image Database Screen

1. Toolbar Buttons – used to edit, print and delete the image files. See [Table 8-1 Toolbar Buttons in JPG Database](#) on page 64 for detailed information.
2. Main Section – displays the stored images.

Table 8-1 Toolbar Buttons in JPG Database

Name	Button	Description
Back		Return to the previous screen.
Enter Edit		Tap to display the editing toolbar to print, delete or view image information.
Cancel		Tap to close the editing toolbar or cancels file search.
Search		Quickly locate the image file by entering the vehicle name, test path, file name or file info.
Info		Tap to open a window displaying the detail information of the image.
Print		Tap to print the selected image.
Delete		Tap to delete the selected image.

➤ **To edit image information**

1. Select **Data Manager** from the MaxiSys Job Menu.
2. Select **Image** to access the JPG database.
3. Select an image to display it in full screen.
4. Tap the screen once to display the editing toolbar.
5. Tap **Info** to open a window displaying the image information.

6. Tap **Edit** on the top right corner of the window. The editing screen displays.
7. Edit the image information by entering the new file name, and file information.
8. Tap **Done** to save the information and exit, or tap **Cancel** to exit without saving.

➤ **To delete selected images**

1. Select **Data Manager** from the MaxiSys Job Menu.
2. Select **Image** to access the JPG database.
3. Tap the **Enter Edit** button to display the editing toolbar.
4. Select the images that need to be deleted by tapping the thumbnail images, the selected thumbnail displays a check mark at the bottom right corner.
5. Tap the **Delete** button, and then **Delete Selected**, now the selected images are deleted.

PDF Files

The PDF section stores and displays all PDF files of saved data. After entering the PDF database, select a PDF file to view the stored information.

This section uses the standard Adobe Reader application for file viewing and editing. Please refer to the associated Adobe Reader manual for more detailed instructions.

Review Data

The Review Data section allows you to playback the recorded data frames of live data streams.

On the Review Data main screen, select a record file to playback.

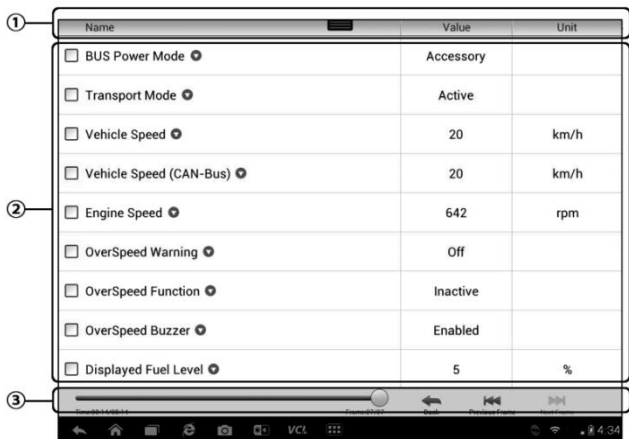

Figure 8-3 Sample Data Playback Screen

1. Drop-down Toolbar – tap the button at the top center of the screen to open the Drop-down Toolbar.
2. Main Section – displays the recorded data frames.
3. Navigation Toolbar – allows you to manipulate data playback.

Use the Navigation Toolbar buttons to playback the record data from frame to frame.

Tap **Back** to exit data playback.

Apps Uninstall

This section allows you to manage the firmware applications installed on the MaxiSys Diagnostics System. Selecting this section opens a managing screen, on which you can check all the available vehicle diagnostic applications.

Select the vehicle firmware you want to delete by tapping on the car brand icon, the selected item will display a blue check mark at the upper right corner. Tap the **Delete** button on the top bar to delete the firmware from the system database.

Data Logging

The Data Logging section allows you to launch Support platform directly to view all records of all sent or unsent (saved) data loggings on the diagnostic system. For more details, please refer to [Data Logging](#) on Page 82.

9 Settings

Selecting Settings application opens a setup interface, on which you can adjust default setting and view information about the MaxiSys system. The following options are available for the MaxiSys system settings:

- Unit
- Language
- Printing Setting
- Wired Network
- Notification Center
- Multitask
- Auto Update
- System Settings
- About

Operations

This section describes the operation procedures for the settings.

Unit

This option allows you to adjust the measurement unit for the diagnostic system.

- **To adjust the unit setting**
 1. Tap the **Settings** application on the MaxiSys Job Menu.
 2. Tap the **Unit** option on the left column.
 3. Select the required measurement unit, Metric or English. A check mark will display to the right of the selected unit.
 4. Tap the **Home** button on the top left corner to return to the MaxiSys Job Menu. Or select another setting option for the system setup.

Language

This option allows you to adjust the display language for the MaxiSys system.

- **To adjust the language setting**
 1. Tap the **Settings** application on the MaxiSys Job Menu.

2. Tap the **Language** option on the left column.
3. Select the required language. A check mark will display to the right of the selected language.
4. Tap the **Home** button on the top left corner to return to the MaxiSys Job Menu. Or select another setting option for the system setup.

Print

Printing Setting

This option allows you to print any data or information anywhere and anytime either via PC network or WiFi.

➤ **To setup the printer connection**

1. Tap **Settings** on the MaxiSys Job Menu.
2. Tap **Printing Setting** on the left column.
3. Tap the **Print via Network** item to activate the printing function, which enables the device to send files to the printer through the PC via WiFi or Ethernet connection.
4. Tap **Home** on the top left corner to return to the MaxiSys Job Menu. Or select another setting option for the system setup.

Printing Operations

➤ **To install the MaxiSys Printer driver program**

1. Download **Maxi PC Suite** from www.autel.com > Supports & Updates > Firmware & Downloads > Update Client, and install to a Windows-based PC.
2. Double click on **Setup.exe** item.
3. Select the installation language and the wizard will load.
4. Follow the instructions on the screen and Click **Next** to continue.
5. Click **Install** and the printer driver program will be installed onto the computer.
6. Click **Finish** to complete the installation.

NOTE

The MaxiSys Printer runs automatically after the installation.

This section describes how to receive file from the MaxiSys tablet and perform printing through the computer:

➤ **To perform printing through the computer**

1. Make sure the tablet is connected to the computer network, either via WiFi or LAN, before printing.
2. Run the **MaxiSys Printer** program on the computer.

3. Click **Test Print** to make sure the printer is working successfully.
4. Tap the **Print** button on the toolbar of the tablet. A test document will be sent to the computer.
 - If the **Auto Print** option in the MaxiSys Printer is selected, the MaxiSys Printer will print the received document automatically.
 - If the **Auto Print** option is not selected, click **Open PDF File** button to view all the temporary files. Select the file(s) to print and click **Print**.

 **NOTE**

Make sure the computer installed with the Printing Services program is connected to a printer.

Wired Network

This option allows you to enable or disable the wired network connectivity, as well as to perform Ethernet configuration.

➤ **To operate Ethernet configuration**

1. Tap Settings on the MaxiSys Job Menu.
2. Tap Wired Network on the left column.
3. Tap ON/OFF to enable the Wired Network connection. If the connectivity is enabled the button turns blue, or if disabled the button turns gray.
4. Tap the > button to the right of the Ethernet Configuration option, a setup window displays.
5. Select a connection type:
 - DHCP – obtains the LAN IP address automatically.
 - Static IP – allows manual input of IP address.
 - a. If Static IP is selected, you need to enter the IP values manually.

 **NOTE**

If you are not sure about the specific IP address values, please contact your network administrator.

- b. Tap **Save** to save the Ethernet configuration setting; or tap **Cancel** to exit without saving.
- c. Tap the **Home** button on the top left corner to return to the MaxiSys Job Menu. Or select another setting option for the system setup.

Notification Center

This option allows you to turn the Notification Center function on or off. The Notification Center function configures the MaxiSys tablet to receive regular online messages from

the server for system update notifications or other service information via the Internet. It is highly recommended to keep this function on all the time, so you won't miss out any new update for MaxiSys or event from Autel. Internet access is required for receiving online messages.

➤ **To enable the Notification Center function**

1. Tap **Settings** on the MaxiSys Job Menu.
2. Tap **Notification Center** on the left column.
3. Tap **ON/OFF** to enable or disable the Notifications function. If the function is enabled the button displays blue, or if disabled the button displays gray.
4. Tap **Home** on the top left corner to return to the MaxiSys Job Menu. Or select another setting option for the system setup.

When the Notification Center function is turned on, and new messages are received by the MaxiSys device, a notification message displays on the MaxiSys Job Menu. Press on the message bar and drag it down to display a list of received messages. Slide the list up or down to view additional messages if present.

Tap a specific message to launch the corresponding application. For example, if you tap on an Update notification message, the Update application will be launched.

Multitask

The Multitask option allows you to turn the Multitask function on or off. The Multitask feature enables you to browse and navigate more freely among different applications on the MaxiSys system. Tap the Multi Task button, the Multi Task menu displays all active applications.

➤ **To enable the Multitask function**

1. Tap **Settings** on the MaxiSys Job Menu.
2. Tap **Multitask** on the left column.
3. Tap **ON/OFF** to enable or disable the Multitask function. If the function is enabled the button displays blue, or if disabled the button displays gray.
4. Tap **Home** on the top left corner to return to the MaxiSys Job Menu. Or select another setting option to configure another system setting.

Auto Update

This option allows you to set the specific time for updating software automatically. There are three update options: OS Update, MaxiSys Update and Vehicle Update.

Tap **ON/OFF** to enable Auto Update. If the connectivity is enabled the button turns blue, or if disabled the button turns gray. Then set the time of the day for updating. If a

specific time is set, the selected software will be automatically updated at this specific time.

System Settings

This option provides you a direct access to the Android background system setting interface, on which you can adjust various system settings for the Android system platform, regarding wireless and networks settings, various device settings such as sound and display, as well as system security settings, and check the associated information about the Android system. Refer to Android documentation for additional information.

About

The About option provides information of the MaxiSys diagnostic device including the product name, version, hardware, and serial number.

➤ To check the MaxiSys product information in About

1. Tap the **Settings** application on the MaxiSys Job Menu.
2. Tap the **About** option on the left column. The product information screen displays on the right.
3. Tap the **Home** button on the top left corner to return to the MaxiSys Job Menu, or select another setting option for the system setup, after viewing.

10 Update

The internal programming of the MaxiSys Diagnostic System, known as the firmware, can be updated using the Update application. Firmware updates increase the MaxiSys applications' capabilities, typically by adding new tests, new models, or enhanced applications to the database.

The display device automatically searches for available updates for all of the Maxisys components when it is connected to the Internet. Any updates that are found can be downloaded and installed on the device. This section describes installing an update to the MaxiSys Diagnostic System firmware. A notification message displays if an update is available when the Notifications function is enabled in the Settings application (See [Notification Center](#) on page 69).

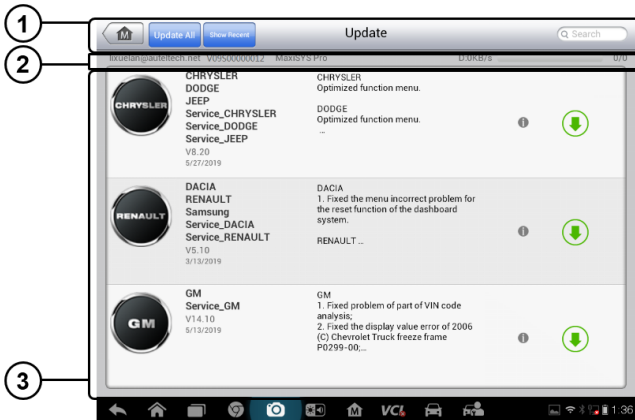

Figure 10-1 Sample Update Screen

1. Navigation and Controls
 - Home Button – returns to the MaxiSys Job Menu.
 - Update All – available updates for all tablet systems.
 - Search Bar – searches specific update item by inputting the file name, for example: a specific vehicle manufacturer.
2. Status Bar
 - Left Side – displays the MaxiSys device model information and serial number
 - Right Side – displays an update progress bar indicating the completion status
3. Main Section
 - Left Column – displays vehicle logos and update firmware version information.

- Middle Column – displays a brief introduction about the new changes to the firmware operation or capabilities. Tap **i** button to display an information screen to view more details, and tap the dim area around to close the window.
- Right Column – according to the operation status of each firmware item, the button displays differently.
 - a) Tap **Update** to update the selected item.
 - b) Tap **Pause** to suspend the updating procedure.
 - c) Tap **Continue** to go on updating the suspended update.

➤ **To update the firmware**

1. Power up the tablet, and ensure that it is connected to a power source and has a steady Internet connection.
2. Tap the **Update** application button from the MaxiSys Job Menu; or tap the update notification message when received. The Update application screen displays.
3. Check all available updates:
 - If you decide to update all the items, tap the **Update All** button.
 - If you only want to update some individual items, tap the **Update** button on the right column of the specific item.
4. Tap the **Pause** button to suspend the updating process. Tap **Continue** to resume the update and the process will continue from the pause point.
5. When the updating process is completed, the firmware will be installed automatically. The new version will replace the older version.

11 VCI Manager

This application allows you to pair the tablet with the VCI device, and to check the communication status.

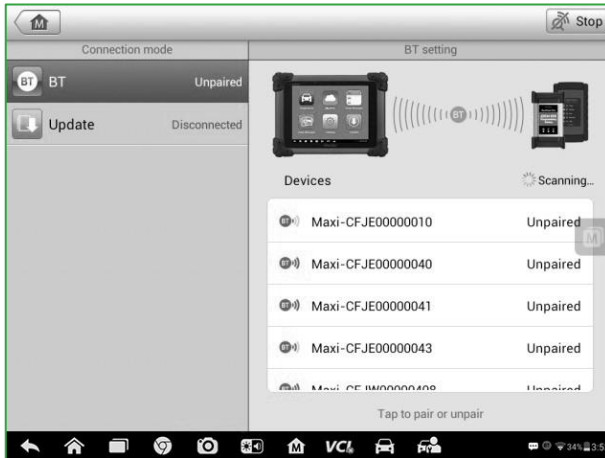

Figure 11-1 Sample VCI Manager Screen

1. **Connection Mode** – there are two connection modes available for selection. The connection state is displayed alongside.
 - BT Pairing – when paired to a wireless device, the connection state displays as Paired; otherwise it displays as Unpaired.
 - Update (for VCI software only) – update VCI software via Internet through the MaxiSys tablet networking using USB connection.
 - Select a connection mode to manage and set up connection.
2. **Settings** – this section allows you to manage wireless pairing or set up network connection.
 - BT Setting – searches and displays the type and partial serial number for all of the devices available for pairing. Tap a required device to start pairing. The BT status icon displayed to the left of the device name indicates the received signal strength.
 - Ethernet Setting – allows you to perform network configuration.

BT Pairing

The VCI device needs to be either connected to a vehicle or to an available power source, so that it is powered up during the synchronization procedure. Make sure the tablet has a charged battery or is connected to an AC/DC power supply.

➤ **To pair the VCI device with the tablet**

1. Power on the tablet.
2. Connect the 15-pin end of the data cable to the Wireless BT Diagnostic Interface's vehicle data connector.
3. Connect the 16-pin end of the data cable to the vehicle data link connector (DLC).
4. Tap **VCI Manager** on the MaxiSys Job Menu of the tablet.
5. Select **BT**, short for Bluetooth, from the connection mode list.
6. Tap **Scan** at the top right corner. Now the device starts searching for available pairing units.
7. Depending on the VCI type you use, the device name may display as Maxi suffixed with a serial number. Select the required device for pairing.
8. When pairing is successfully done, the connection status displayed to the right of the device name is shown as Paired.
9. Wait a few seconds, and the VCI button on the system Navigation bar at the bottom of the screen shall display a green tick icon, indicating the tablet is connected to the VCI device.
10. Tap the paired device listing again to unpair it.
11. Tap **Back** on the top left to return to the MaxiSys Job Menu.

 **NOTE**

A VCI device can be paired to only one tablet each time, and once it's been paired, the device will not be discoverable for any other unit.

Before update the VCI software, please make sure the tablet network connection is stable.

➤ **To update the VCI device software**

1. Power on the tablet.
2. Connect the VCI device to the tablet via USB.
3. Tap **VCI Manager** on the MaxiSys Job Menu of the tablet.
4. Select **Update** from the connection mode list.
5. The current version and the latest version of the VCI software will be displayed after a few seconds, click **Update Now** to update the VCI software if available.

12 Remote Desk

The Remote Desk application launches the TeamViewer Quick Support program, which is a simple, fast and secure remote control interface. You can use the application to receive ad-hoc remote support from Autel's support centre, colleagues, or friends, by allowing them to control your MaxiSys tablet on their PC via the TeamViewer software.

Operations

If you think of a TeamViewer connection as a phone call, the TeamViewer ID would be the phone number under which all TeamViewer Clients can be reached separately. Computers and mobile devices that run TeamViewer are identified by a globally unique ID. The first time the Remote Desk application is started, this ID is generated automatically based on the hardware characteristics and will not change.

Make sure the tablet is connected to the Internet before launching the Remote Desk application, so that the tablet is able to receive remote support from the third party.



Figure 12-1 Sample Remote Desk Screen

➤ **To receive remote support from a partner**

1. Power on the tablet.
2. Tap the **Remote Desk** application on the MaxiSys Job Menu. The TeamViewer interface displays and the device ID is generated and shown.
3. Your partner must install the Remote Control software to his/her computer by downloading the TeamViewer full version program online (<http://www.teamviewer.com>). Start the software on his/her computer at the

same time, in order to provide support and take control of the tablet remotely.

4. Provide your ID to the partner, and wait for him/her to send you a remote control request.
5. A message displays to ask for your confirmation to allow remote control on your device.
6. Tap **Allow** to accept, or tap **Deny** to reject.

Refer to the associated TeamViewer documents for additional information.

13 Support

This application launches the Support platform which synchronizes Autel's online service base station with the MaxiSys display tablet. In order to synchronize the device to your online account, you need to register the product through the Internet when you use it for the first time. The Support application is connected to Autel's service channel and online communities that provides the quickest way for problem solutions, allowing you to submit complaints or send help requests to obtain direct service and support.

Product Registration

In order to get access to the Support platform and obtain update and other services from Autel, you are required to register the MaxiSys Diagnostic Device the first time you use it.

➤ **To register the diagnostic device**

1. Visit the website: <http://pro.autel.com>.
2. If you have an Autel account, Sign In with your account ID and password.
3. If you are a new member to Autel, click on the **Create Autel ID** button on the left side to create an ID.
4. Enter the required information in the input fields, and click **Get Verification Code** button to get the verification code for email validation.
5. The online system will automatically send a verification code to the registered email address. Input the code in the Verification Code field and fill in the other input fields, read through Autel's Terms and Conditions and click on **Agree**, and then click **Create Autel ID** at the bottom. A product registration screen will display.
6. The device's serial number and password is located in the *About* section of the Settings application on the tablet.
7. Select your product model, enter the product serial number and password on the Product Registration screen, and click **Submit** to complete the registration procedure.

Support Screen Layout

The Support application interface is navigated by 4 simple buttons on the top navigation bar, operation of each is described below in turn from left to right:

- Home Button – returns to the MaxiSys Job Menu.

- Back – returns to the previous screen, each press takes you one step backwards.
- Forward – each press moves forward one screen until you've reached the last screen visited.
- Refresh – reloads and updates the screen.

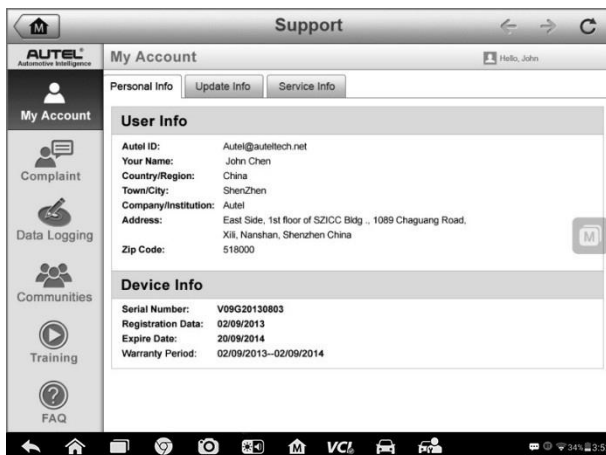

Figure 13-1 Sample Support Application Screen

The main section of the Support screen is divided into two sections. The narrow column on the left is the main menu; selecting one subject from the main menu displays the corresponding functional interface on the right.

My Account

The My Account screen displays the comprehensive information of the user and the product, which is synchronized with the online registered account, including User Info, Device Info, Update Info and Service Info.

Personal Info

The User Info and Device Info are both included under the Personal Info section.

- User Info – displays detailed information of your registered online Autel account, such as your Autel ID, Name, Address and other contact information.
- Device Info – displays the registered product information, including the Serial Number, Registration Date, Expire Date, and Warranty Period.

Update Info

The Update Info section displays a detailed record list of the product's software update history, including the product serial number, software version or name, and the update time.

Service Info

The Service Info section displays a detailed record list of the device's service history information. Every time the device has been sent back to Autel for repair, the device's serial number and the detailed repair information, such as the fault type, changed components, or system reinstallation will be recorded and updated to the associated online product account that will be synchronized to the Service Info section.

User Complaint

The User Complaint screen allows you to establish a new complaint case, as well as to view historical complaint records.

Screen Layout

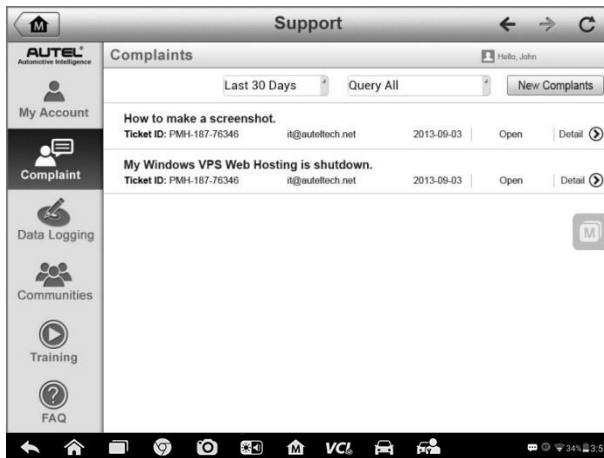

Figure 13-2 Sample Complaint Screen

The User Complaint screen consists of two parts.

1. Option Bar

- Period Filter – displays only the complaint records within the defined period on the list
- Status Filter – displays the corresponding complaint records according to the selected case status
- New Complaint Button – starts a new complaint case.

2. Complaint List

The complaint list normally displays all the complaint records of all time and all status by default. The summary information for each complaint item includes the Subject Name, Ticket ID, User's Account ID, Date, and the Case Status.

There are four kinds of the case status:

- Open – indicates the complaint case has been started but not processed yet
 - Suspended – indicates the complaint case is being processed
 - Waiting Customer Reply – indicates the complaint has been replied to by the service personnel, and requires feedback from the customer
 - Closed – indicates the complaint case has been processed, solved, and ended
- To view the detailed complaint session, tap the > button on the right side of the case item.
- **To establish a new complaint session**
1. Register the product online.
 2. Tap **Support** on the MaxiSys Job Menu. The device information is automatically synchronized with the online account.
 3. Tap **Complaint** on the Main Menu.
 4. Tap **New Complaint** at the upper right corner. A selection menu with a category of service channels displays.
 5. Select your target service channel and click **Next** to continue. A standard complaint form displays, on which you are allowed to enter detailed information, such as personal information, vehicle information, and device information, you can also attach image or PDF files with the form.
 6. Enter in each input field the appropriate information. To settle the complaint more efficiently, it is recommended to complete the form with as much detail as possible.
 7. Select the required processing time on the last section according to the urgency of the case.
 8. Tap **Submit** to send the completed form to Autel's online service center, or tap **Reset** to refill it. The submitted complaints will be carefully read and handled by the service personnel.
- **To make a reply in a complaint session**
1. Register the product online.
 2. Tap **Support** on the MaxiSys Job Menu. The device information is automatically synchronized with the online account. Tap **Complaint** on the Main Menu.
 3. Select an existing complaint case item on the record list by tapping the > button on its right side. The screen displays the complaint session details.
 4. Tap the **Post Reply** button on the upper right side after viewing, to make a reply. An edit screen will display.
 5. Input the content in the input field, and if necessary, upload an attached file.
 6. Tap **Submit** to post the reply.
 7. Tap the **States** selection drop-down menu to reset a case state.

8. Tap the **Update** button to commit the newest update.

Data Logging

The Data Logging section keeps records of all sent or unsent (saved) data loggings on the diagnostic system. The support personnel will receive and process the submitted reports through the Support platform. The solution will be sent back within 48 hours. You may continue to correspond with Support until the issue is resolved.

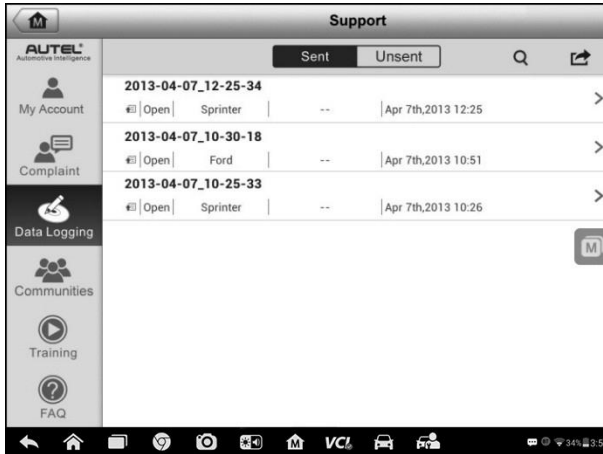

Figure 13-3 Sample Data Logging Screen

- **To make a reply in a Data Logging session**
 1. Tap on the **Sent** tag to view the list of submitted data loggings.
 2. Select the latest message from Support.
 3. Tap on the input field on the bottom of the screen, and enter your reply. Or tap the Audio button to record a voice message, or tap the camera button to take a screenshot.
 4. Tap **Send** to deliver your message to Support.

Communities

The Communities section launches and synchronizes with the Technical Forums on Autel's official website www.autel.com, where you can discuss technical topics or share information with other members of Autel's online community.

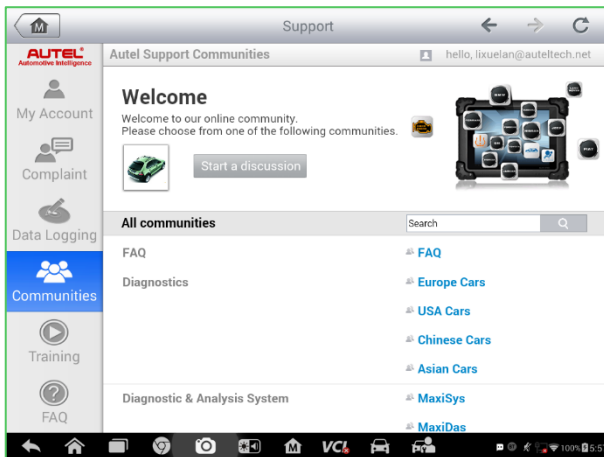

Figure 13-4 Sample Communities Home Screen

➤ **To start a discussion**

1. Tap **Start a discussion** on the Communities Home screen. A list of the major forums is displayed.
2. Based on your interest, select a discussion topic. For example, if you are going to ask a question about the MaxiSys tablet, tap **MaxiSys** to start a discussion.
3. Input text in the space provided.
4. Select a category or edit tags for the discussed post. This will help members with similar interest to find your post.
5. Tap **OK** to submit the post.

➤ **To join and reply to a discussion post**

1. Select a forum group that you are interested in, whether by the product or by the features, on the Communities Home screen. A list of the latest posts is displayed.
2. Select a specific category on the Categories menu to better pinpoint the topics you are most interested with.
3. Tap the **>** button on the right side of the topic item to view the discussion. The posts contents are displayed.
4. Browse through all the posts by sliding the screen up and down. Tap **Go to original post** when reaching the end of the discussion to return to the first post.
5. Tap **Reply** to reply to a specific post, or tap **Reply to original post** to join and continue the whole discussion.
6. Enter your comment in the input field, and tap **OK** to submit your post.

User Profile

The User Profile section allows you to set a profile photo, check your member status and other information, as well as to review your posts in the communities.

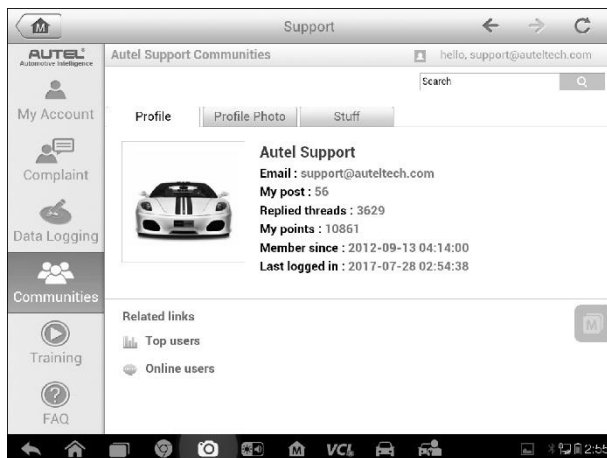

Figure 13-5 Sample User Profile Screen

Tap the profile photo on the Communities screen to open the User Profile.

- **Profile** – displays the user’s personal information and member status. The **Related links** allow you to check the Top Users (ranked according to their points and levels) in the communities, and to connect with other users.
- **Profile Photo** – allows you to select an image to set as your profile photo to be displayed in the communities.
- **Stuff** – displays all the discussions you’ve posted on various forums

Training Channels

The Training section provides quick links to Autel’s online video accounts. Select a video channel by language to see all available Autel online tutorial videos on such topics as product usage techniques and vehicle diagnostics practices.

FAQ Database

The FAQ section provides you comprehensive and abundant references for all kinds of questions frequently asked and answered about the use of Autel’s online member account, and shopping and payment procedures.

- **Account** – displays questions and answers about the use of Autel’s online user account.

- Shopping & Payment – displays questions and answers about online product purchase and payment methods or procedures.

14 Academy

Autel provides various tutorial articles and technical bulletins produced by top-notch technicians and product experts. Please view the materials that are saved on the tablet or view technical articles from our online forum by clicking the links displayed under this application.

15 Quick Link

The Quick Link application provides you with convenient access to Autel's official website and many other well-known sites in automotive service, which offers you abundant information and resources, such as technical help, knowledge base, forums, training, and expertise consultations.

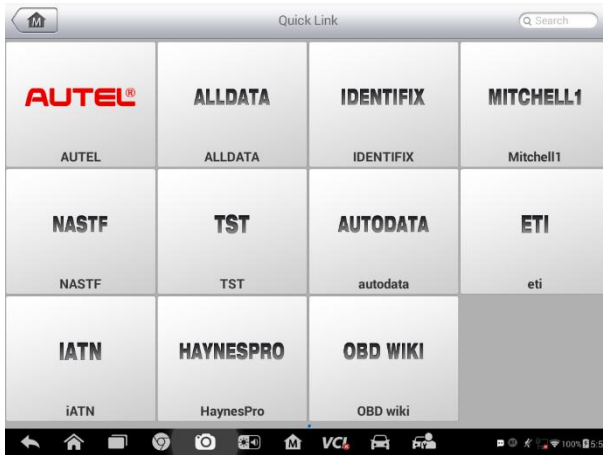

Figure 15-1 Sample Quick Link Screen

➤ **To open a quick link**

1. Tap **Quick Link** on the MaxiSys Job Menu. The Quick Link application screen displays.
2. Select a website thumbnail from the main section. The Chrome browser is launched and the selected website is opened.
3. Now you can start exploring the website!

16 MaxiScope

The MaxiScope application configures the MaxiSys Diagnostic Device to operate as an automotive oscilloscope when used in combination with the MaxiScope module. This function provides all the features needed for performing electrical and electronic circuit tests as well as monitoring signal activities on any modern vehicles, which shows you what is really going on with a vehicle's electrical system

Please download the latest user manual for Autel MaxiScope device from www.autel.com.

17 Digital Inspection

The Digital Inspection application configures the MaxiSys Diagnostic Device to operate as a digital video scope by simply connecting the tablet to a Digital Inspection Camera. This function allows you to examine difficult-to-reach areas normally hidden from sight, with the ability to record digital still images and videos, which offers you an economical solution to inspect machinery, facilities, and infrastructure in a safe and quick way.

WARNINGS & IMPORTANTS:

Follow these instructions to reduce the risk of injury from electric shock, entanglement and other causes and prevent tool damage.

- Do not place the image head and cable into anything or anywhere that may contain a live electric charge or moving parts, which increases the risk of electric shock or entanglement injuries.
- Do not use the image head cable to modify surroundings, clear pathways or clogged areas.
- When inspection is completed, carefully withdraw the imager head cable from the inspection area.
- The image head cable are waterproof to a depth of 3m (10'), greater depths may cause leakage into the imager head cable and cause electric shock or damage the tool.
- The working temperature of the imager head is between 32 °F (0 °C) and 113 °F (45 °C).

Check-Ups:

- ✓ **FOR AUTOMOBILES:** Ensure the automobile is not running during inspection. Metal and liquid under the hood may be hot. Don't get oil or gas on the imager head.
- ✓ **FOR PIPES:** If you suspect a metal pipe could contain an electric charge, have a qualified electrician to check the pipe before using.
- ✓ **FOR WALLS:** For inspecting the inside walls, be sure to shut off the circuit breaker to the whole house before using the tool.
- ✓ **WORK AREA:** Ensure the work area has sufficient light.

Additional Accessories

The Digital Inspection Camera and its fittings are the additional accessories. Both sizes (*8.5 mm and 5.5 mm*) of the imager head are optional and available for purchase along with the standard MaxiSys tool kit.

Digital Inspection Camera

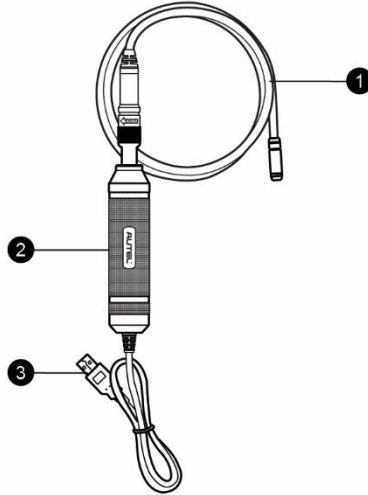

Figure 17-1 Digital Inspection Camera

1. Removable Imager Head Cable – connects to the tool when performing digital inspections for image and video viewing.
2. Handgrip – ergonomically designed handle for comfortable grips and agile operation.
3. USB Cable – connects the Digital Inspection Camera to MaxiSys tablet.

Imager Head Accessories

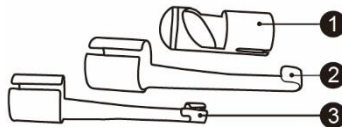

Figure 17-2 8.5mm Imager Head Accessories

1. Magnet – picks up small metal objects, such as dropped rings or screws.
2. Hook – unclogs obstacles and picks up wires in the pipes or confined areas.
3. Mirror – helps to look around corners and see the unreachable areas.

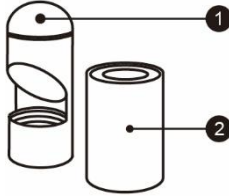

Figure 17-3 5.5mm Imager Head Accessories

1. Mirror – helps to look around corners and see the unreachable areas.
2. Magnet – picks up small metal objects, such as dropped rings or screws.

Accessory Assembly

For 8.5mm Imager Head

The three accessories, including the Magnet, Hook, and Mirror, can be attached to the Imager Head with the same manner described below:

1. Hold the accessory and the imager head.

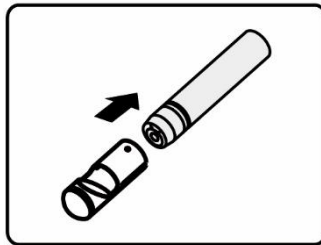

2. Slip the end of the accessory over the imager head and then fix the accessory.

For 5.5mm Imager Head

The two accessories, including the Magnet and Mirror, can be attached to the Imager Head with the same manner described below:

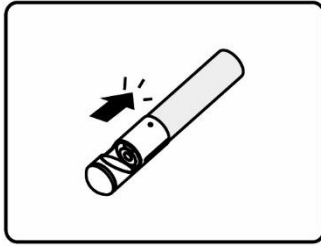

1. Hold the accessory and the imager head.

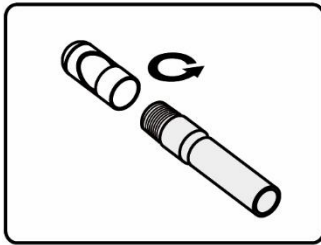

2. Screw the thread part of the accessory over the imager head to fix the accessory.

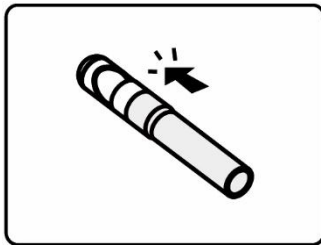

Technical Specifications

Table 17-1 Specifications

Item	Description
Optimal Distance Viewing	1" to 14" (2.54cm to 35.56cm) with 8.5mm diameter imager head 3/8" to 12" (0.95cm to 30cm) with 5.5mm diameter imager head
Image Capture	JPG images (640x480) AVI videos (320 x 240)

Item	Description
Operating Temperature	Main Unit: 0°C to 55°C (ambient) Cable: -10°C to 70°C
Storage Temperature	-20°C to 75°C (ambient)
Waterproof	Imager head and cable to 1m
Weigh	0.3 kg with 8.5 mm diameter imager head 0.2 kg with 5.5 mm diameter imager head

Operations

Before performing the Digital Inspection application, the Imager Head Cable must be connected to the tablet through the USB port. Install the correct imager head accessories for use in the appropriate application.

NOTE

When in operation, the imager head cable can be bent into a certain shape. This may help you operate the cable into confined areas.

➤ **To take pictures using the Digital Inspection application**

1. Connect the Imager Head Cable to the USB port on the top side of the tablet.
2. If not already done, power up the tablet.
3. Tap the **Digital Inspection** application on the MaxiSys Job Menu. The Digital Inspection application interface displays, showing a camera operating screen. The default camera is now the Imager head.
4. Select the **camera** icon at the lower right corner to take photos.
5. Focus the image to be captured in the view finder by adjusting and properly locating the imager head cable.
6. Tap the blue ring on the operating screen. The view finder now displays the captured picture and auto-saves the taken photo.
7. Tap the thumbnail image on the top right corner of the screen to view the stored image, slide the screen left and right to view the images one by one.
8. Tap on the selected image and the edit toolbar instantly displays.
9. Tap the appropriate button to **share**, **delete**, or **edit** the image.
10. Tap the **Back** or **Home** button on the Navigation bar at the bottom of the screen to exit the Digital Inspection application.

➤ **To record a video using the Digital Inspection application**

1. Connect the Imager Head Cable to the USB port on the top side of the tablet.
2. If not already done, power up the tablet.

3. Tap the **Digital Inspection** application on the MaxiSys Job Menu. The Digital Inspection application interface displays, showing a camera operating screen. The default camera is now the Imager head.
 4. Select the **video** icon at the lower right corner to record a video.
 5. Properly locate the imager head cable to focus the inspection scene for recording.
 6. Tap the red ring on the operating screen to start recording.
 7. Tap the red circle again to stop recording. The recorded video is automatically saved to the system Gallery.
 8. Tap the thumbnail image on the top right corner to review the recorded video.
 9. Tap the **Play** button to play the video.
 10. Tap on the selected video and the edit toolbar instantly displays.
 11. Tap the appropriate button to **share**, **delete**, or **edit** the video.
 12. Tap the **Back** or **Home** button on the Navigation bar at the bottom of the screen to exit the Digital Inspection application.
- **To configure various settings for the work mode of the imager head**
1. Tap  button at the bottom edge of the circle.
 2. Select each item to make appropriate adjustments.

For more tips and detailed information about the camera application, please refer to associated Android documentations.

18 Maintenance and Service

To ensure that the tablet and the combined VCI unit perform at their optimum level, we advise that the product maintenance instructions covered in this section is read and followed.

Maintenance Instructions

The following shows how to maintain your devices, together with precautions to take.

- Use a soft cloth and alcohol or a mild window cleaner to clean the touch screen of the tablet.
- Do not use any abrasive cleansers, detergent, or automotive chemicals to the tablet.
- Maintain the devices in dry conditions and keep them within normal operating temperatures.
- Dry your hands before using the tablet. The touch screen of the tablet may not work if the touch screen is moist, or if you tap the touch screen with wet hands.
- Do not store the devices in humid, dusty or dirty areas.
- Check the housing, wiring, and connectors for dirt and damage before and after each use.
- At the end of each work day, wipe the device housing, wiring, and connectors clean with a damp cloth.
- Do not attempt to disassemble your tablet or the VCI unit.
- Do not drop or cause severe impact to the devices.
- Use only authorized battery chargers and accessories. Any malfunction or damage caused by the use of unauthorized battery charger and accessories will void the limited product warranty.
- Ensure that the battery charger does not come in contact with conductive objects.
- Do not use the tablet beside microwave ovens, cordless phones and some medical or scientific instruments to prevent signal interference.

Troubleshooting Checklist

- A. When the tablet does not work properly:
 - Make sure the tablet has been registered online.
 - Make sure the system software and diagnostic application software are

properly updated.

- Make sure the tablet is connected to the Internet.
 - Check all cables, connections, and indicators to see if the signal is being received.
- B. When battery life is shorter than usual:
- This may happen when you are in an area with low signal strength. Turn off your device if it is not in use.
- C. When you cannot turn on the tablet:
- Make sure the tablet is connected to a power source or the battery is charged.
- D. When you are unable to charge the tablet:
- Your charger maybe out of order. Contact your nearest dealer.
 - You may be attempting to use the device in an overly hot/cold temperature. Charge the device in a cooler or warmer area.
 - Your device may have not been connected to the charger properly. Check the connector.

 **NOTE**

If the problems persist, please contact Autel's technical support personnel or your local selling agent.

About Battery Usage

Your tablet is powered by a built-in Lithium-ion Polymer battery. This means that, unlike other forms of battery technology, you can recharge your battery while some charge remains without reducing your tablet's autonomy due to the "battery memory effect" inherent in those technologies.

 **DANGER**

The built-in Lithium-ion Polymer battery is factory replaceable only; incorrect replacement or tampering with the battery pack may cause an explosion.

- Do not use a damaged battery charger.
- Do not disassemble or open crush, bend or deform, puncture or shred.
- Do not modify or remanufacture, attempt to insert foreign objects into the battery, expose to fire, explosion or another hazard.
- Use only the included charger and USB cables. Failure to use Autel-authorized charger and/or USB cables, may result in device malfunction or failure.
- Use of an unqualified battery or charger may present a risk of fire, explosion, leakage, or another hazard.
- Avoid dropping the tablet. If the tablet is dropped, especially on a hard surface, and the user suspects damage, take it to a service center for inspection.

- The closer you are to your network's wireless router, the longer your tablet usage time because less battery power is consumed for the connection.
- The battery recharging time varies depending on the remaining battery capacity.
- Battery life inevitably shortens over time.
- Since overcharging may shorten battery life, remove the tablet from its charger once it is fully charged. Unplug the charger, once charging is complete.
- Leaving the tablet in hot or cold places, especially inside a car in summer or winter, may reduce the capacity and life of the battery. Always keep the battery within normal temperatures.

Service Procedures

This section introduces information for technical support, repair service, and application for replacement or optional parts.

Technical Support

If you have any question or problem on the operation of the product, please contact us.

AUTEL NORTH AMERICA

- **Phone:** 855-AUTEL-US (855-288-3587) Monday-Friday 9am-6pm EST
- **Website:** www.autel.com
- **Email:** ussupport@autel.com
- **Address:** 175 Central Avenue, Suite 200, Farmingdale, New York, USA 11735

AUTEL EUROPE

- **Phone:** 0049 (0) 61032000522
- **Website:** www.autel.eu
- **Email:** sales.eu@autel.com, support.eu@autel.com
- **Address:** Robert-Bosch-Strasse 25, 63225, Langen, Germany

AUTEL CHINA HQ

- **Phone:** 0086-755-86147779
- **Website:** www.autel.com
- **Email:** support@autel.com
- **Address:** 6th-10th floor, Building B1, Zhiyuan, Xueyuan Road, Xili, Nanshan, Shenzhen, 518055, China.

AUTEL SOUTH AMERICA

- **Phone:** (+507) 308-7566
- **Website:** www.autel.com/es
- **Email:** sales.latin@autel.com, latsupport@autel.com
- **Address:** Office 103, Building 3845, International Business Park, Veracruz, Panamá Pacífico, Panamá

AUTEL AUSTRALIA

- **Phone:** 03 9480 2978 / +61 476293327
- **Website:** www.autel.com.au
- **Email:** sales@autel.com.au
- **Address:** 155 Islington Street, Melbourne, Collingwood, VIC 3066

For technical assistance in other markets, please contact your local selling agent.

Repair Service

If it becomes necessary to return your device for repair, please download the repair service form from www.autel.com, and fill in the form. The following information must be included:

- Contact name
- Return address
- Telephone number
- Product name
- Complete description of the problem
- Proof-of-purchase for warranty repairs
- Preferred method of payment for non-warranty repairs

NOTE

For non-warranty repairs, payment can be made with Visa, Master Card, or with approved credit terms.

Send the device to your local agent, or to the below address:

6th-10th Floor, Building B1, Zhiyuan,

Xueyuan Road, Xili, Nanshan,

Shenzhen, 518055, China

Other Services

You can purchase the optional accessories directly from Autel's authorized tool suppliers, and/or your local distributor or agent.

Your purchase order should include the following information:

- Contact information
- Product or part name
- Item description
- Purchase quantity

19 Compliance Information

FCC Compliance

FCC ID: WQ8MAXISYSMS908S

This equipment has been tested and found to comply with the limits for a Class B digital device, pursuant to Part 15 of the FCC Rules. These limits are designed to provide reasonable protection against harmful interference in a residential installation. This equipment generates uses and can radiate radio frequency energy and, if not installed and used in accordance with the instructions, may cause harmful interference to radio communications. However, there is no guarantee that interference will not occur in a particular installation. If this equipment does cause harmful interference to radio or television reception, which can be determined by turning the equipment off and on, the user is encouraged to try to correct the interference by one or more of the following measures:

- Reorient or relocate the receiving antenna.
- Increase the separation between the equipment and receiver.
- Consult the dealer or an experienced radio/TV technician for help.

This device complies with part 15 of the FCC Rules. Operation is subject to the following two conditions:

- (1) This device may not cause harmful interference, and
- (2) this device must accept any interference received, including interference that may cause undesired operation.

Changes or modifications not expressly approved by the party responsible for compliance could void the user's authority to operate the equipment.

SAR:

The radiated output power of this device is below the FCC radio frequency exposure limits. Nevertheless, the device should be used in such a manner that the potential for human contact is minimized during normal operation.

The exposure standard for wireless devices employs a unit of measurement known as the Specific Absorption Rate, or SAR. The SAR limit set by the FCC is 1.6 W/Kg. Tests for SAR are conducted using standard operating positions accepted by the FCC with the device transmitting at its highest certified power level in all tested frequency bands. Although the SAR is determined at the highest certified power level, the actual SAR level of the device while operating can be well below the maximum value. This is because the device is designed to operate at multiple power levels so as to use only the

power required to reach the network. To avoid the possibility of exceeding the FCC radio frequency exposure limits, human proximity to antenna should be minimized.

20 Warranty

12-Month Limited Warranty

Autel Intelligent Technology Corp., Ltd. (the Company) warrants to the original retail purchaser of this MaxiSys Diagnostic Device that should this product or any part thereof during normal usage and under normal conditions be proven defective in material or workmanship that results in product failure within twelve (12) months period from the date of purchase, such defect(s) will be repaired, or replaced (with new or rebuilt parts) with Proof of Purchase, at the Company's option, without charge for parts or labor directly related to the defect(s).

The Company shall not be liable for any incidental or consequential damages arising from the use, misuse, or mounting of the device. Some states do not allow limitation on how long an implied warranty lasts, so the above limitations may not apply to you.

This warranty does not apply to:

- a) Products subjected to abnormal use or conditions, accident, mishandling, neglect, unauthorized alteration, misuse, improper installation or repair or improper storage;
- b) Products whose mechanical serial number or electronic serial number has been removed, altered or defaced;
- c) Damage from exposure to excessive temperatures or extreme environmental conditions;
- d) Damage resulting from connection to, or use of any accessory or other product not approved or authorized by the Company;
- e) Defects in appearance, cosmetic, decorative or structural items such as framing and non-operative parts.
- f) Products damaged from external causes such as fire, dirt, sand, battery leakage, blown fuse, theft or improper usage of any electrical source.

! IMPORTANT

All contents of the product may be deleted during the process of repair. You should create a back-up copy of any contents of your product before delivering the product for warranty service.
